

Installation

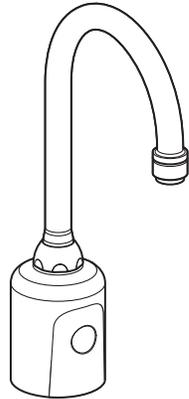

Aerada 1000

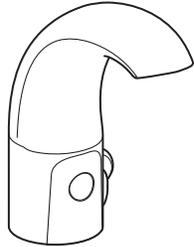

Aerada 1100

Aerada 1000 Series Faucet
S53-326 AC Gooseneck
S53-327 DC Gooseneck

Aerada 1100 Series Faucet
S53-328 AC High Arc Infrared
S53-329 DC High Arc Infrared

Table of Contents

Supplies Required.....	2
Installation.....	4
Manual Settings	6
Adjustments.....	9
Troubleshooting	10
Care and Maintenance	12
Multi-Faucet Transformer Wiring	14



IMPORTANT!



Read this entire installation manual to ensure proper installation. When finished with the installation, file this manual with the owner or maintenance department. Compliance and conformity to local codes and ordinances is the responsibility of the installer.



Separate parts from packaging and make sure all parts are accounted for before discarding packaging material. If any parts are missing, do not begin installation until you obtain the missing parts.

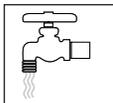

Make sure that all water supply lines have been flushed and then completely turned off before beginning installation. Do not use pipe dope. Debris in supply lines can cause valves to malfunction.



Product warranties may be found under "Products" on our web site at www.bradleycorp.com.

SAFETY INFORMATION

Read this entire user guide to ensure proper installation.

Compliance and conformity to local codes and ordinances is the responsibility of the installer.

The following safety notes must always be complied with during handling of this product:

- Make sure there is enough space and lighting available during installation and service.
- Do not modify or convert this Faucet; any modifications will void warranties.



Installation may be performed at different times of construction by different individuals. For this reason, these instructions should be left on-site with the facility or maintenance manager.



Pressurized plumbing fixtures shall be installed in accordance with manufacturer’s recommendations. The supply piping to these devices shall be securely anchored to the building structure to prevent installed device from unnecessary movement when operated by the user. Care shall be exercised when installing the device to prevent marring the exposed significant surface.



EXPLANATION OF SYMBOLS

Symbol	Meaning
	WARNING Refers to a situation of potential danger that may cause serious injury or death.
	CAUTION Refers to a situation of potential danger that may cause slight or medium injury or property damage.
	Refers to important information.

ACCESSORIES

	BRADLEY PART NO.
4" Cover Plate	150-221
Plugin Transformer	232-008
Hardwired Transformer (1–8 faucets)	232-009
2.2 GPM Laminar Flow for Gooseneck	269-1923
2.2 GPM Laminar Flow for Lavatory	269-1922
6V Lithium Battery CR-P2	261-010

TECHNICAL SUPPORT

For additional technical assistance, visit our website or call us:

- www.bradleycorp.com
- 1-800-BRADLEY

ORDERS

For orders, contact your local representative, visit our website or call us:

- www.bradleycorp.com
- 1-800-BRADLEY

**COMPONENT PARTS
Aerada 1100 Series**

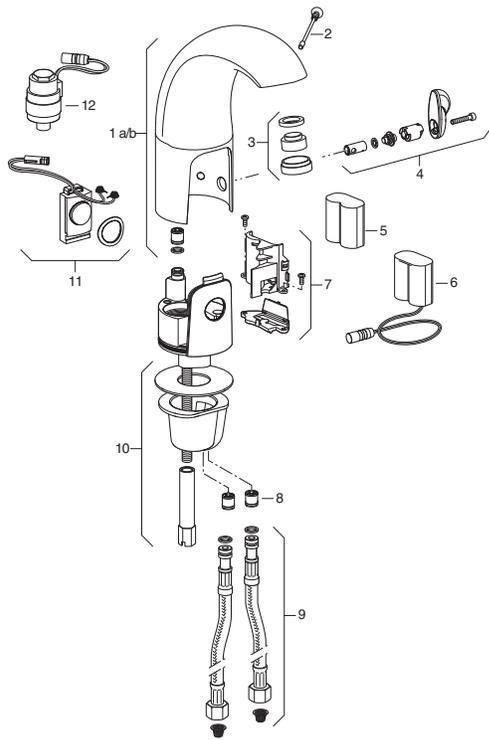

High Arc Components & Bradley Part Nos.

1. Spout with External Mixer opening [269-1960]
2. Shut Off Screw Assembly [269-1944]
3. Outlet Assembly Kit Lavatory Spout (.5 GPM) [269-1946]
4. Mixer Kit [269-1945]
5. 6 V Lithium Battery CR-P2 [261-010]
6. AC Adaptor Kit [269-1942]
7. Battery Holder Kit [269-1961]
8. Check Valve (1) [198-013]
9. Braided Hose (1) with inlet filter [269-1943]; Filter only [269-1948]
10. Deck Mounting Hardware Kit [269-1949]
11. Electronics Module Kit [269-1941]
12. Solenoid Valve [269-1940]

**COMPONENT PARTS
Aerada 1000 Series**

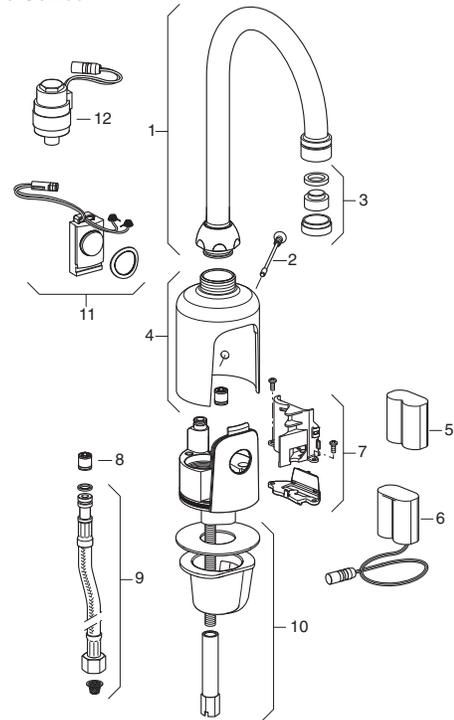

Gooseneck Components & Bradley Part Nos.

1. Spout [269-1958]
2. Shut Off Screw Assembly [269-1944]
3. Outlet Assembly Kit Spout (.5 GPM) [269-1947]
4. Gooseneck Base without opening [269-1959]
5. 6 V Lithium Battery CR-P2 [261-010]
6. AC Adaptor Kit [269-1942]
7. Battery Holder Kit [269-1961]
8. Check Valve (1) [198-013]
9. Braided Hose (1) with inlet filter [269-1943]; Filter only [269-1948]
10. Deck Mounting Hardware Kit [269-1949]
11. Electronics Module Kit [269-1941]
12. Solenoid Valve [269-1940]

INSTALLATION

This faucet comes with all the components needed for installation, however, some tools and supplies are not included.

- Basin Wrench
- Adjustable Wrench
- Adjustable Locking Pliers
- Plumber's Putty
- Hex Key (supplied)
- Outlet Key (supplied)



Do not use pipe dope on faucet and supply connections. Possible solenoid contamination could occur and will void any warranty.

Mounting of Lavatory and Gooseneck Faucet

Prerequisites

- Supply valve is installed
- Water supply lines are flushed properly
- For AC faucets, power outlet is installed



It is not necessary to unscrew the connection between braided hose and housing to install the product.



Do not remove protective covering from sensor until starting up faucet operation.



Do not tighten locknut before step 4 is completed.

- 1 Mount cover plate if required. Plumber's putty is recommended to seal the cover plate to the sink. Security pin must be located on the left side.

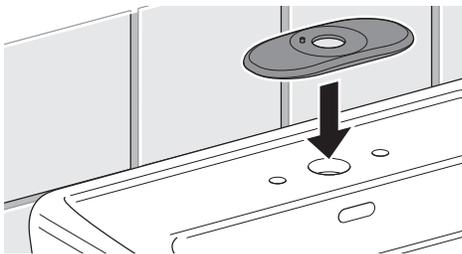

- 2 Mount gasket and put faucet into sink.

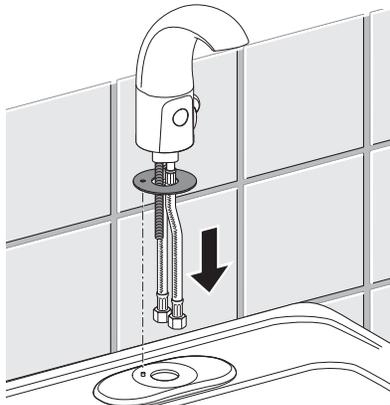

- 3 Mount bracket from underneath. Place hoses through large opening and mounting rod through small opening. Make sure flange sits securely against surface.

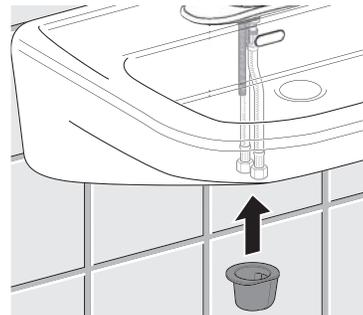

- 4 Place nut onto mounting rod and tighten with wrench.

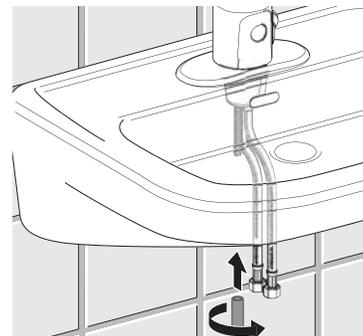

- 5 If faucet was installed with cover plate, secure with basin washer, flat washer and locknut.

- 6 Install aerator and tighten with aerator key (supplied).



- 7 For Gooseneck faucets, tighten spout with wrench.

- 8 Connect braided hose with filter to supply valve
Cold water > white label Hot water > no label

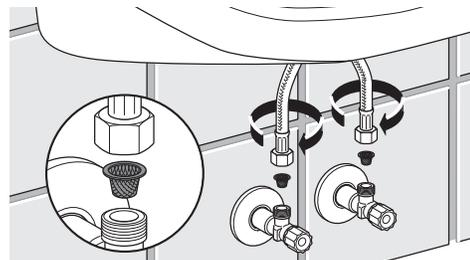

For AC faucets, please refer to the plugin or hardwired transformer installation instructions.

- 9 Connect to power supply.

Result: The faucet is now mounted.

Start-up Operation

Prerequisites

- Faucet is mounted
- Water supply is on
- Water supply lines are flushed properly
- For AC faucets, power outlet is installed.

1 Fully open supply valves.

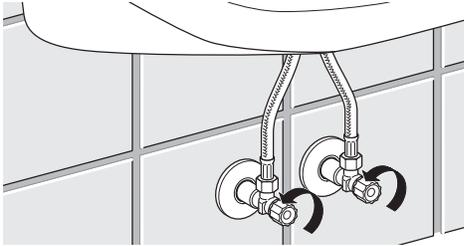

2 Remove all items from sink.

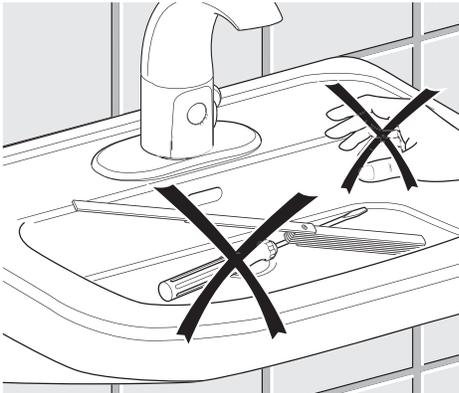

3 Remove protective covering from sensor.

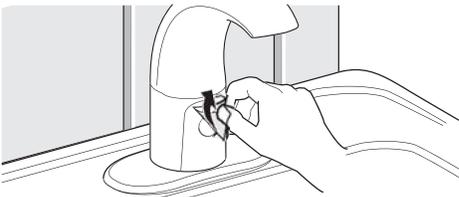

4 Wait for 15 seconds for the faucet to calibrate to its environment.

15 sec.



Result: The faucet is now activated.

Test Function

1 Hold hand in front of sensor.
> Water flow starts

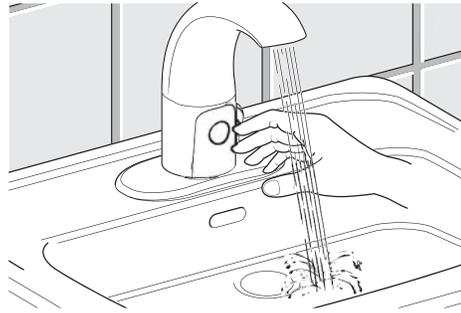

WARNING Hot water may burn your skin.
Hold hand carefully under water and remove quickly

2 For faucets with external mixer, turn mixer handle from cold to warm.
> Water temperature increases

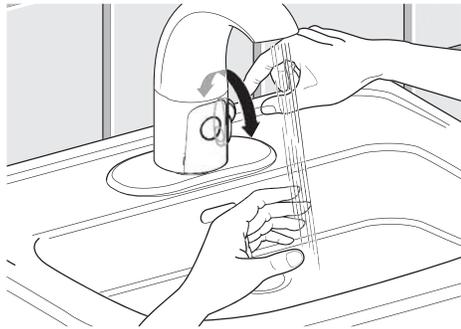

3 Remove hand.
> Water flow stops



Result: The function is now tested.

Enabling “Manual Setting Mode”

A battery model is shown in the following example. These instructions apply to all models. After 30 minutes, the “Manual Setting” mode will be disabled automatically and all settings will be saved.

Prerequisites

- Water supply valve is open
- Battery is full (LED does not blink) for DC faucets
- AC power is on for AC faucets

1 Remove shut-off screw.



2 Remove mixer handle (only for faucets with external mixer).

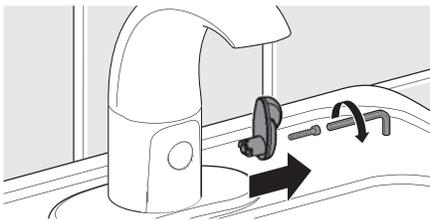

3 Remove housing vertically.

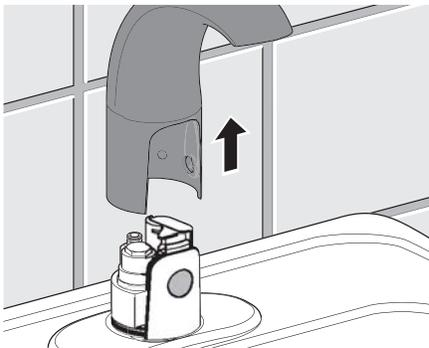

4 Remove battery from battery holder.

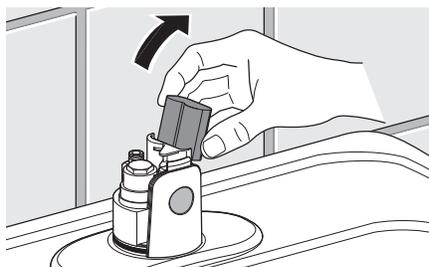

- 5** The following procedure (a, b, c) must be done three (3) times in a row.
- a - Re-insert battery
 - b - LED lights up
 - c - Remove battery immediately after LED switches off

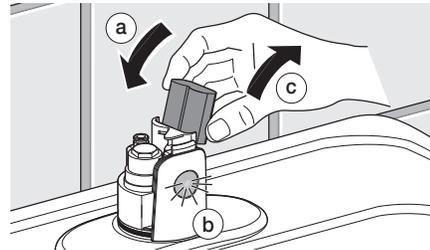

6 Insert battery.

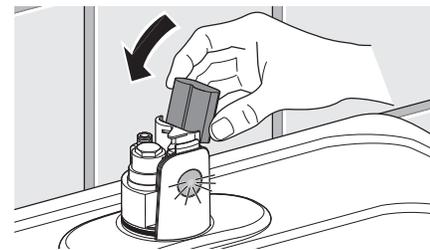

7 Mount housing vertically.

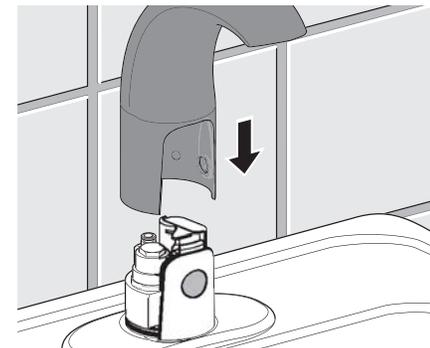

8 Mount shut-off screw.



9 Mount mixer handle (only for faucets with external mixer)

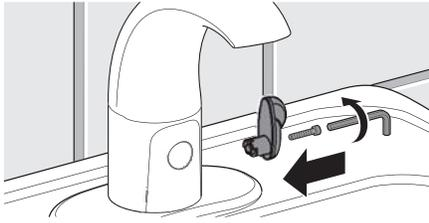

Result: The faucet is now mounted.

A - Setting Cleaning Mode

Setting the cleaning mode will make the faucet inactive for 90 seconds.

- 1 Enable "Manual Setting" Mode
> See "Enabling Manual Setting Mode" section
- 2 Fully cover sensor with hand, until water flow stops. (This takes 5 seconds.)



- 3 Remove hand.

Result: The Cleaning Mode is now active. For the next 90 seconds, the faucet will be inactive.

B - Setting Normal Mode

Setting the normal mode will allow the faucet to activate only when it senses a hand presence.

- 1 Enable "Manual Setting" Mode
> See "Enabling Manual Setting Mode" section
- 2 Fully cover sensor with hand. Water flow stops after 5 seconds - Continue to hold on for one (1) additional water pulse.



- 3 Remove hand.

Result: Normal Mode is now activated.

C - Setting Metering Mode (10 seconds)

Setting the metering mode will allow the faucet to activate for a full 10 seconds after it senses a hand presence.

- 1 Enable "Manual Setting" Mode
> See "Enabling Manual Setting Mode" section
- 2 Fully cover sensor with hand. Water flow stops after 5 seconds - Continue to hold on for another two (2) additional water pulses.



- 3 Remove hand.

Result: Metering Mode is now activated for 10 seconds.

D - Setting Scrub Mode (60 seconds)

Setting scrub mode for 60 seconds will allow the faucet to activate for 60 seconds from the last hand presence.

- 1 Enable "Manual Setting" Mode
> see "Enabling Manual Setting Mode" section
- 2 Fully cover sensor with hand. Water flow stops after 5 seconds - Continue to hold on for another three (3) additional water pulses.

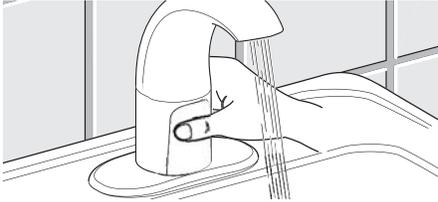

- 3 Remove hand.

Result: Scrub Mode is now activated for 60 seconds.

E - Setting Scrub Mode (180 seconds)

Setting scrub mode for 180 seconds will allow the faucet to activate for 180 seconds from the last hand presence.

- 1 Enable "Manual Setting" Mode
> See "Enabling Manual Setting Mode" section
- 2 Fully cover sensor with hand. Water flow stops after 5 seconds - Continue to hold on for another four (4) additional water pulses.

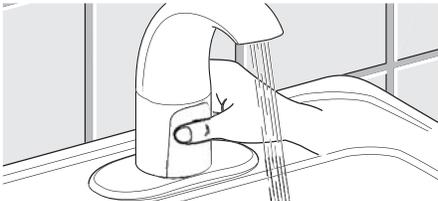

- 3 Remove hand.

Result: Scrub Mode is now activated for 180 seconds.

F - Sensor Range Adjustment

The detection distance of the sensor can be adjusted between approximately 4 - 11 inches from the infrared window.

- 1 Enable "Manual Setting" Mode
> See "Enabling Manual Setting Mode" section
- 2 Remove all items from the sink.

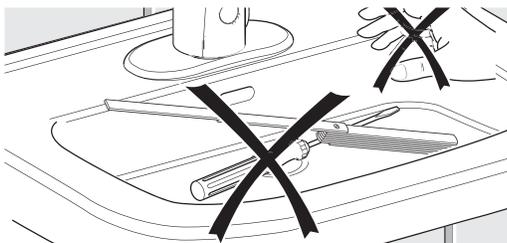

- 2 Fully cover sensor with hand. Water flow stops after 5 seconds - Continue to hold on for five (5) additional water pulses.



- 4 Remove hand.
- 5 Hold hand in the current detection area until LED flashes. Then move hand to the desired detection distance. When LED stays lit for two (2) seconds, detection distance has been re-set to new location.



Result: The detection distance is now calibrated.

G - Reset

All settings will be reset to default setting. The "Manual Setting" Mode will be disabled.

> The procedure for the reset is the same as "Enabling Manual Setting Mode", but step 5 needs to be done six (6) times in a row.

Result: All settings are reset to default settings and the manual-setting-mode is now disabled.

FAUCET ADJUSTMENTS

Operating modes and sensor ranges can be adjusted with a manual operation through the infrared sensor.

Faucet adjustment operations apply to all models.

OPERATING MODES

Operating Modes	Description
A Cleaning Mode	The faucet is inactive for 90 seconds.
B Normal Mode	The faucet is activated if it senses a hand presence. This is the default operating mode of the faucet.
C Metering Mode (10 s)	The faucet will shut off after 10 seconds regardless of hand presence detected.
D Scrub Mode (60 s)	The faucet will shut off 60 seconds after the detection of the last hand presence.
E Scrub Mode (180 s)	The faucet will shut off 180 seconds after the detection of the last hand presence.
F Sensor Range Adjustment	Change the detection distance of the infrared sensor. The default sensor range is approximately 1" beyond the spout.
G Reset	All settings will be reset to original factory settings.

In order to set the operating modes, the faucet needs to be placed into "Manual Setting" mode. At this time, operating modes can be changed within the next 30 minutes.

The following is a functional diagram to show the different settings available for manual faucet adjustment. See detailed instructions on pages 6 through 8.

FUNCTION DIAGRAM OF OPERATING MODES

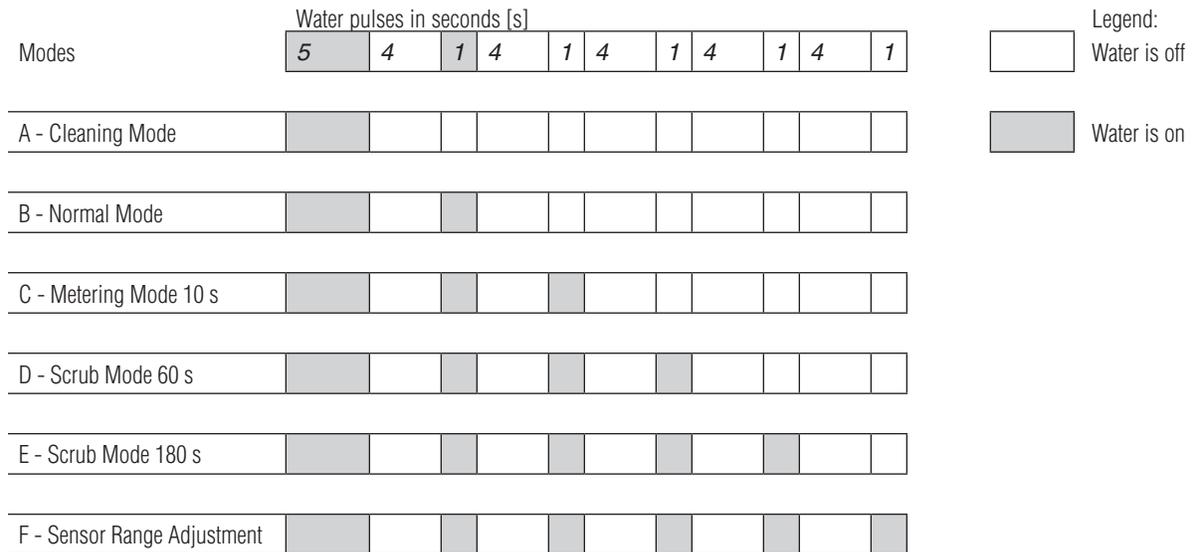

TROUBLESHOOTING

Problem	Possible Cause	Solution
No water flow	<i>Supply valves are closed</i>	Open supply valves
	<i>Aerator is blocked or dirty</i>	Clean or replace aerator (See "Care and Maintenance")
	<i>Inlet water line filter is dirty or blocked</i>	Clean or replace filter (See "Care and Maintenance")
	<i>Braided hose is kinked</i>	Eliminate braided hose kink
	<i>No external water pressure</i>	Check water pressure/Provide water pressure
	<i>Battery is drained (DC faucets only)</i>	Replace battery (See "Care and Maintenance")
	<i>Battery contacts are corroded (DC faucets only)</i>	Clean contacts or replace battery (See "Care and Maintenance")
	<i>Reverse battery insertion</i>	Insert battery correctly
	<i>Connector between transformer and power adapter unplugged (AC faucets only)</i>	Plug connector
	<i>Power adapter contacts are corroded (AC faucets only)</i>	Clean contacts
	<i>Connecting cable is kinked or broken (AC faucets only)</i>	Replace defective parts (See "Replacement Parts")
	<i>No external power supply (AC faucets only)</i>	Check external power supply/Provide power supply
	<i>Shut-off screw is missing or defective</i>	Replace shut-off screw (See "Replacement Parts")
	<i>Solenoid valve inoperable</i>	Replace solenoid valve (See "Replacement Parts")
	<i>Faucet is in cleaning mode</i>	Wait for cleaning mode to end (appr. 90 seconds)
	<i>Electronics module inoperable</i>	Contact Bradley technical service or replace power adapter (See "Replacement Parts")
	<i>Power adapter defective (AC faucets only)</i>	Contact Bradley technical service or replace power adapter (See "Replacement Parts")
	<i>Sensor distance is not adjusted properly</i>	Reset sensor monitoring range Remove and re-install shut-off screw. Do not disturb sensor scanning procedure (wait until water flow stops and LED switches off)
<i>Infrared window scratched or dirty</i>	Clean window with smooth cloth	

Problem	Possible Cause	Solution
Water runs continuously and stops when object present	<i>Connector between electronics module and solenoid valve plug is reversed</i>	Plug connector properly
Water runs continuously	<i>Interfering object is in monitoring range</i>	Remove object from monitoring area Remove and re-install shut-off screw. Do not disturb sensor scanning procedure (wait until water flow stops and LED switches off)
	<i>Defective electronics module</i>	Replace electronics module (See "Replacement Parts")
	<i>Improper sensor mode</i>	Change mode or reset sensor (See "Care and Maintenance")
	<i>External water pressure too high</i>	Check external water pressure Provide pressure between 20 - 125 psi
	<i>Solenoid valve inoperable</i>	Replace solenoid valve (See "Replacement Parts")
Water flows although shut-off screw is removed	<i>Electronics module is inoperable</i>	Replace electronics module (See "Replacement Parts")
	<i>Water drops on infrared window</i>	Clean window with smooth cloth
Faucet turns on by itself	<i>Infrared window is dirty or scratched</i>	Clean window with smooth cloth
	<i>Input line pressure fluctuates</i>	Install appropriate line pressure regulators
Faucet is leaking water	<i>Connections between housing and braided hoses are loose</i>	Check O-rings Replace O-rings when damaged or missing
	<i>Connection between braided hose and inlet supply are loose</i>	Check rubber washers Replace washers when damaged or missing
	<i>Connection between valve body and solenoid valve is loose</i>	Check O-rings Replace O-rings when damaged. Carefully reinstall solenoid valve and do not overtighten.
	<i>Faucet drips, solenoid valve does not close properly</i>	Clean or replace solenoid valve (See "Replacement Parts")
Temperature cannot be adjusted properly	<i>No, or too little hot or cold water. Supply valves are not fully opened</i>	Fully open supply valves
	<i>Inlet water line filter is dirty or blocked</i>	Clean or replace filter (See "Care and Maintenance")
	<i>Braided hose is kinked</i>	Eliminate braided hose kink
	<i>Backflow preventer in faucet inlet is blocked</i>	Unblock backflow preventer
	<i>Temperature of hot or cold water supply is too low</i>	Check inlet water temperature or inspect boiler
	<i>Hot water temperature not sufficient</i>	Reverse hot water limiter (See "Care and Maintenance")
	<i>Braided hoses are connected improperly (cold to hot and hot to cold)</i>	Correct the connections

CARE AND MAINTENANCE INSTRUCTIONS

The following instructions are described in this section:

- Activating Cleaning Mode
- Replacing Battery
- Cleaning or Replacing Inlet Filter
- Adjusting Water Temperature (Internal Mixer)
- Adjusting Hot Water Limiter (External Mixer)
- Cleaning or Replacing Aerator

Activating Cleaning Mode

In order to set the cleaning mode, the faucet needs to be have been set once into the "Manual Setting" mode. See "Manual Setting" instructions. When cleaning mode is activated, the faucet will be inoperable for 90 seconds.

- 1 Fully cover sensor with hand, until water flow stops. (This takes approximately 5 seconds.)

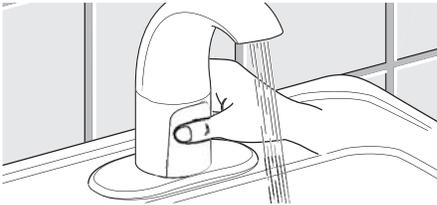

- 2 Remove hand.

Result: Cleaning Mode is now activated.

Replacing Battery

A traditional lavatory faucet is shown as an example. These instructions apply to all DC models.

Prerequisites

- Battery is low (LED is lit)
- New 6 V Lithium battery (CR-P2) is required

- 1 Remove shut-off screw

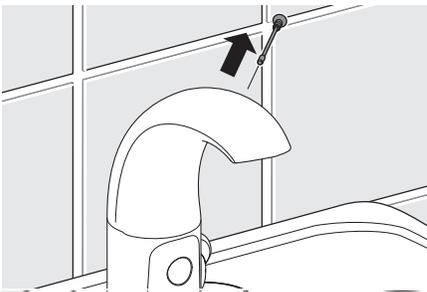

- 2 Remove mixer handle (for faucets with external mixer only)

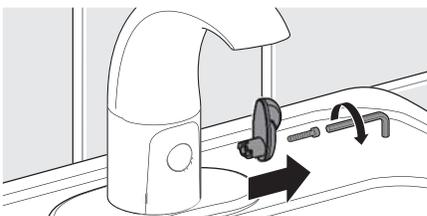

- 3 Remove housing vertically.

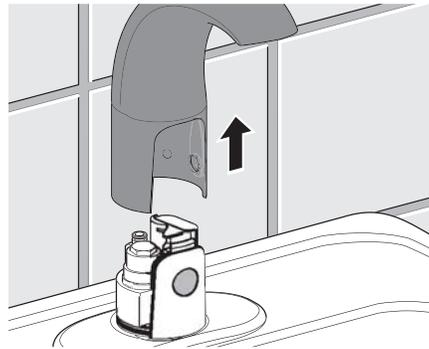

- 4 Remove used battery from battery holder and recycle.

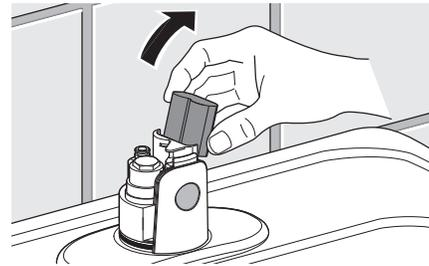

- 5 Insert new battery.
> LED lights up for 1 second

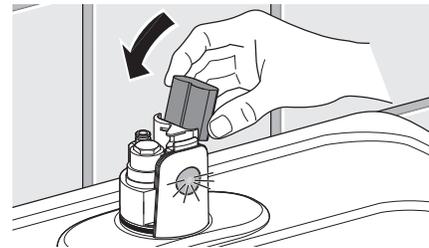

- 6 Mount housing vertically.

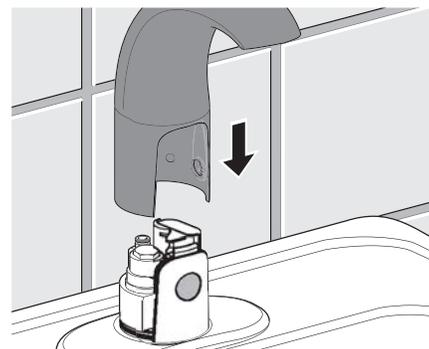

7 Install shut-off screw.



8 Install mixer handle (for faucets with external mixer only).

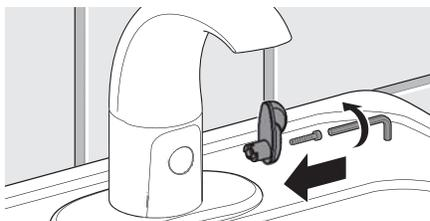

Result: The battery is now replaced.

Cleaning or Replacing Inlet Filter

1 Close supply valves.

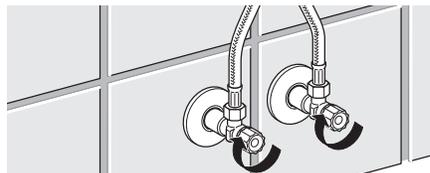

2 Disconnected braided hoses and clean or replace filter (for a new filter, see "common replacement parts").

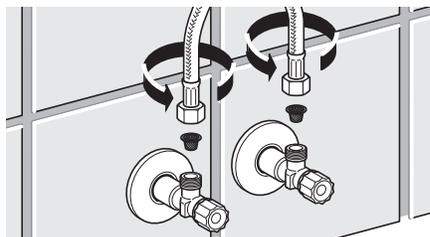

3 Connect braided hose with filter to supply valve
Cold water > white label Hot water > no label

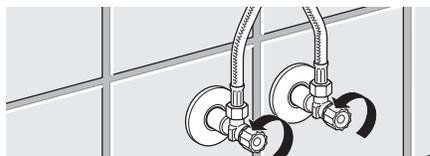

Result: The filter is now cleaned or replaced.

Adjusting Hot Water Limiter (External Mixer)

The proportion of hot water can be switched from approximately 85% to 95% (or reverse) depending upon inlet water pressures and temperatures. The default setting is 85%.



WARNING Hot water may burn your skin.

Hold hand carefully under water and remove quickly

1 Remove mixer handle.

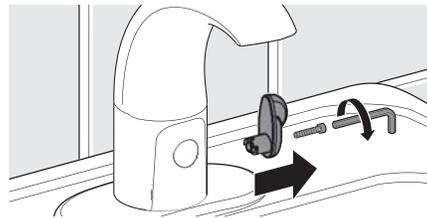

2 Carefully pull out hot water limiter from handle (using pliers) and reverse by 180°.

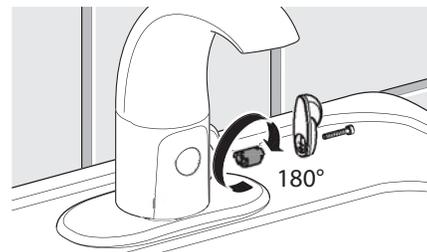

> Settings of hot water limiter (View from placement in mixer handle)

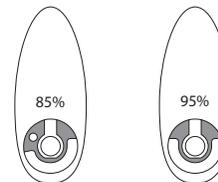

3 Mount mixer handle.

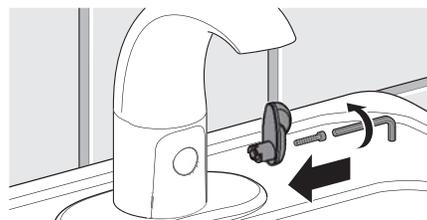

Result: The proportion of hot water is now changed.

Cleaning or Replacing Aerator

1 Remove shut-off screw.



3 Install shut-off screw.



2 Remove aerator with vandal resistant wrench supplied with the faucet. Clean or replace aerator, then reinstall.



Result: The aerator is now cleaned or replaced.

Multi-Faucet Transformer Installaion

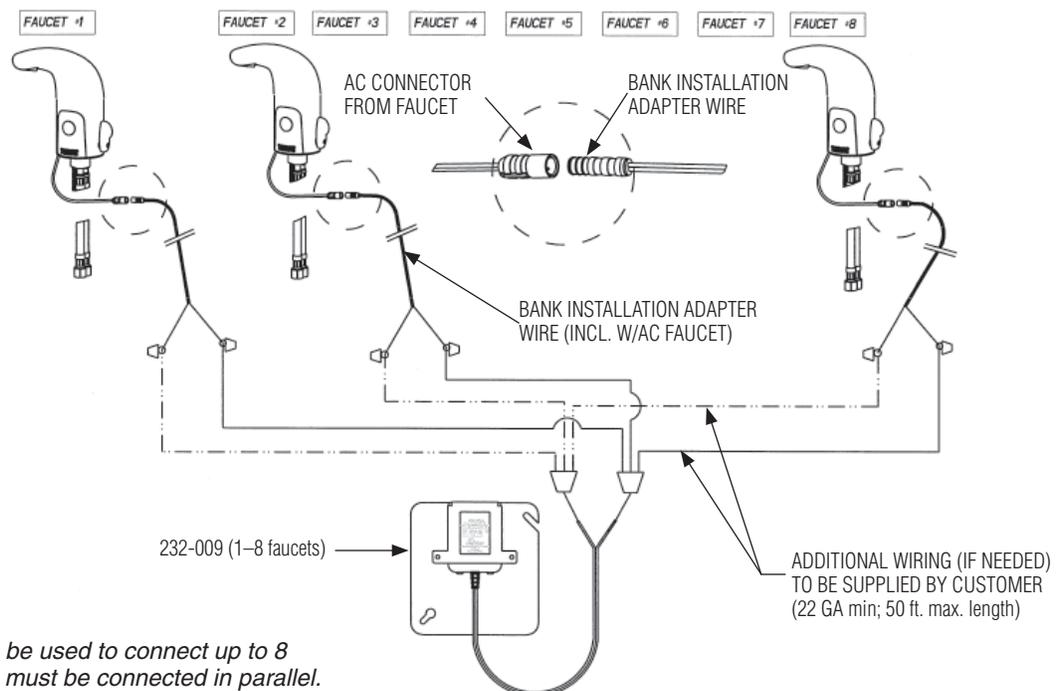

Transformer can be used to connect up to 8 faucets. All units must be connected in parallel.