

# Installation

## S19-310F

### Combination Drench Shower and Eyewash

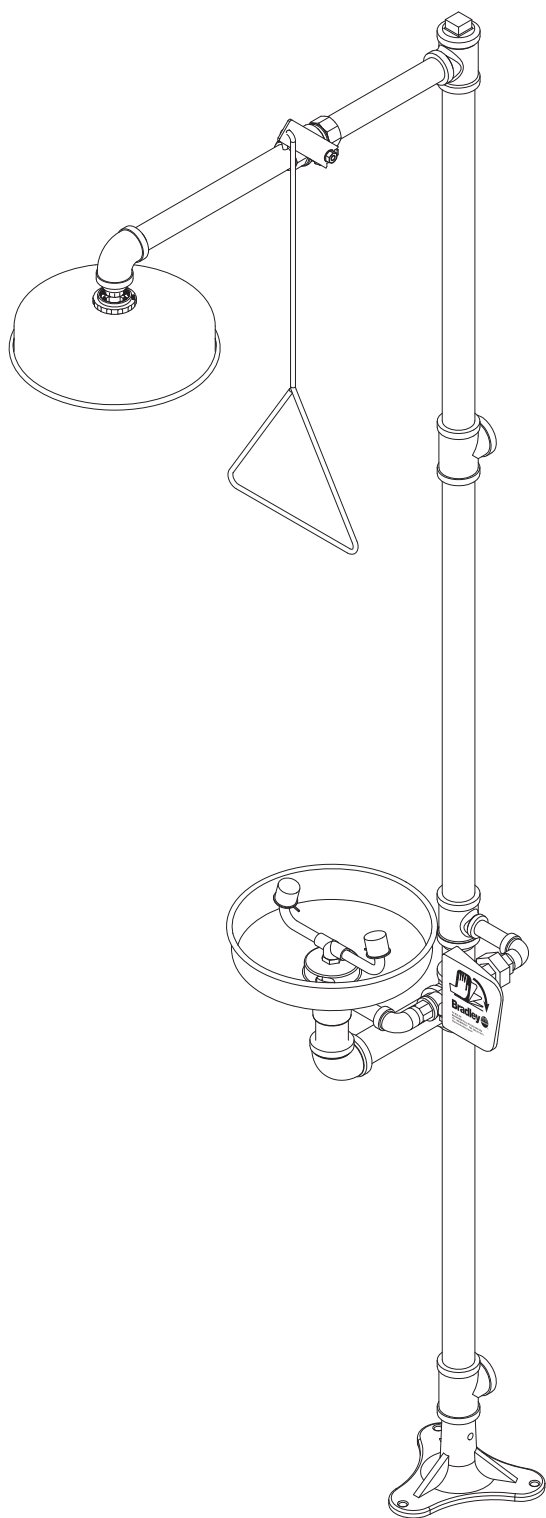

#### Table of Contents

Pre-Installation Information .....	2
Installation Instructions .....	3
Assembly of Components .....	4
Parts List .....	5

 **IMPORTANT** 

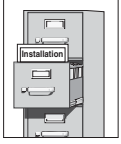

Read this installation manual completely to ensure proper installation, then file it with the owner or maintenance department. Compliance and conformity to drain requirements and other local codes and ordinances is the responsibility of the installer.



Separate parts from packaging and make sure all parts are accounted for before discarding any packaging material. If any parts are missing, do not begin installation until you obtain the missing parts.

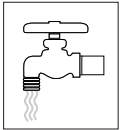

Flush the water supply lines before beginning installation and after installation is complete. Test the unit for leaks and adequate water flow. Main water supply to the eyewash should be "ON" at all times. Provisions shall be made to prevent unauthorized shutoff.



The ANSI Z358.1 standard requires an uninterrupted supply of flushing fluid at a minimum 30 PSI (0.21 MPa) flowing pressure. Flushing fluid should be tepid per ANSI Z358.1.

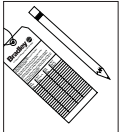

The inspection and testing results of this equipment should be recorded weekly to verify proper operation. This equipment should be inspected annually to ensure compliance with ANSI Z358.1.



Workers who may come in contact with potentially hazardous materials should be trained regarding the placement and proper operation of emergency equipment per ANSI Z358.1.



For questions regarding the operation or installation of this product, visit [www.bradleycorp.com](http://www.bradleycorp.com) or call 1-800-BRADLEY.

Product warranties and parts information may also be found under "Products" on our web site at [www.bradleycorp.com](http://www.bradleycorp.com).

# Installation

## Supplies Required:

- (3) 3/8" floor anchors and bolts
- Teflon tape and pipe sealant
- Piping to 1-1/4" NPT water supply inlet and to 1-1/4" NPT drain outlet on unit
- Adequate supply pipe supports
- Min. 4" drain to accommodate 30 gallons per minute discharge for shower waste
- OPTIONAL: sign-mounting hardware

*NOTE: Local codes may require the installation of a backflow prevention valve to complete proper installation. Compliance with local codes is the responsibility of the installer. Valve must be tested annually to verify that it is functioning properly. Backflow prevention valves are not included with the fixture and may be supplied by the contractor or purchased from Bradley Corporation.*

## Step 1: Secure base to floor

1. Install three suitable anchors (supplied by installer) for 3/8" bolts in the floor.
2. Bolt the base to the floor anchors using 3/8" bolts (supplied by installer).

## Step 2: Assemble components

1. Assemble the remaining unit components as shown on page 4.
  - Apply pipe sealant (by installer) to all male-threaded pipe joints.
  - Use the rubber grip pad provided or a strap wrench around pipes when tightening to prevent marring. Place the grip pad on the pipe, then put the wrench over the grip pad and turn the pipe with the wrench.
  - Bottom edge of showerhead should be 7'-1" (2159mm) from floor.

## Step 3: Connect water supply



**IMPORTANT: Do not rely on Bradley's Combination Unit to support supply piping.**

1. Connect water supply piping to 1-1/4" NPT inlet on unit (piping by installer). Provide adequate supports (by installer) for supply pipe using pipe hangers or other means.
2. Connect drain piping to 1-1/4" NPT drain outlet on unit (piping by installer).
3. Hang the safety sign from the unit with the curtain hooks provided (or mount it to the wall using sign-mounting hardware by installer).

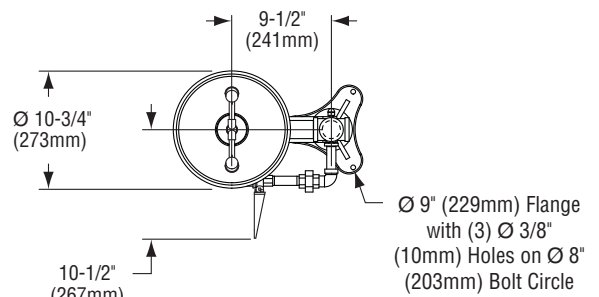
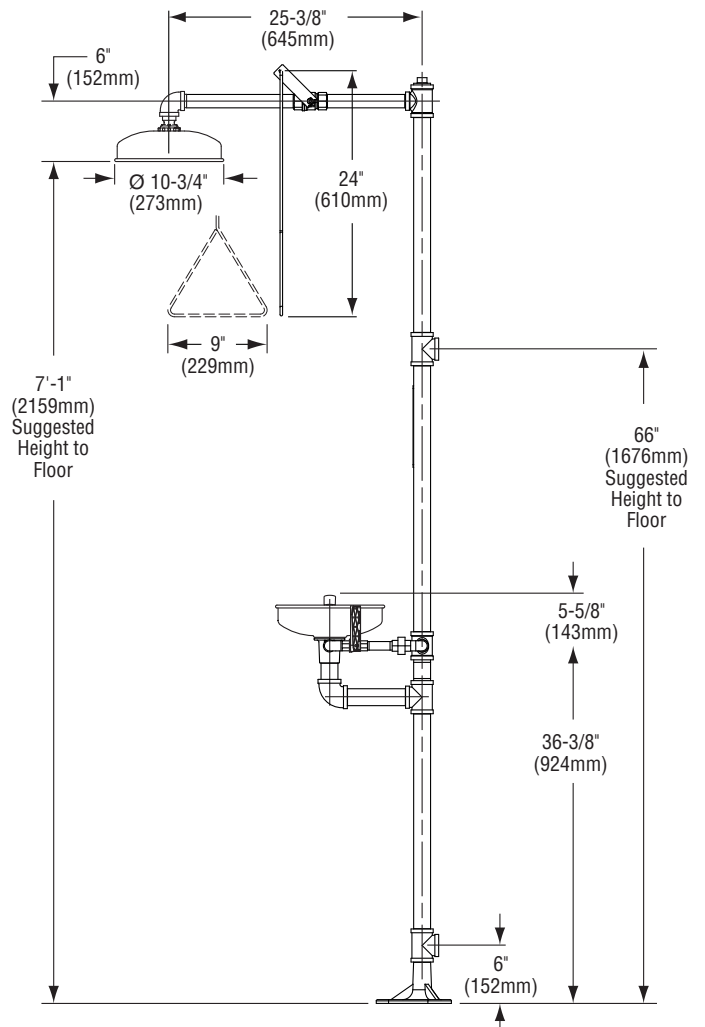

Top View From Bowl

**NOTE: All dimensions assume standard thread engagement. Variations in manufacturing allow for +/- 1/8" (3mm) per threaded joint. To find the tolerance of a dimension, add the number of thread joints in between a dimension and multiply it by 1/8" (3mm).**

# Assembly of Components

NOTE: If tee (Item 7) is used as a supply inlet, use plug (Item 8) on tee (Item 2).

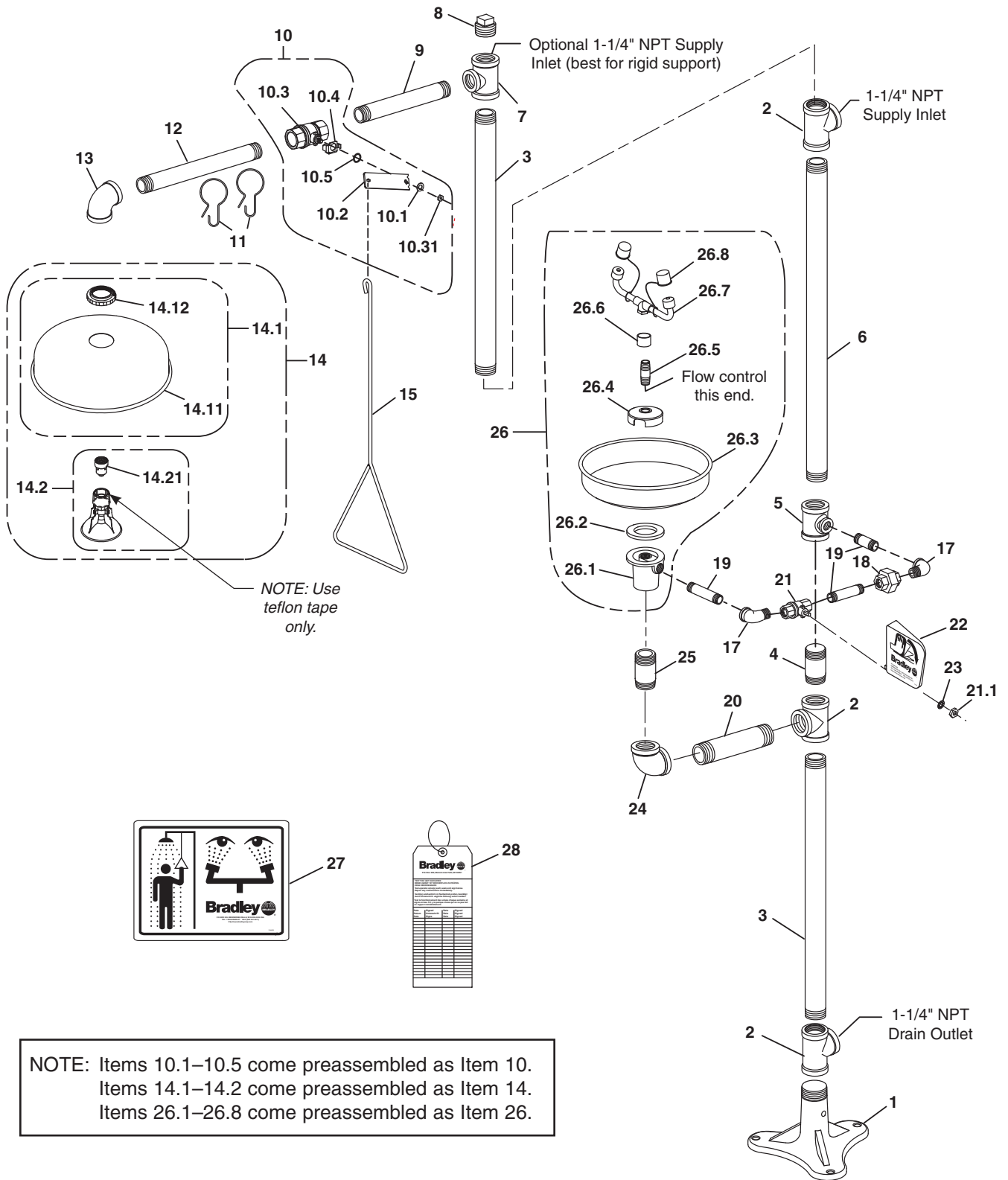

NOTE: Items 10.1–10.5 come preassembled as Item 10.  
 Items 14.1–14.2 come preassembled as Item 14.  
 Items 26.1–26.8 come preassembled as Item 26.

## Parts List

Item	Part No.	Qty	Description	Item	Part No.	Qty	Description
1	131-059	1	Base	14.21	S24-187	1	Flow Control Assembly, 23 GPM
2	169-727	3	Pipe Tee 1-1/4" NPT	15	128-156A	1	Pull Rod - 24" Long
3	113-006LW	2	Pipe 1-1/4" NPT x 22-1/2" Lg.	16	269-915	1	Grip Pad (not shown)
4	S06-136	1	Plugged Nipple 1-1/4" NPT x 3"	17	169-025	2	Elbow 1/2" NPT
5	169-841	1	Reducing Tee	18	169-726	1	Union 1/2" Female NPT
6	113-006LC	1	Pipe 1-1/4" NPT x 27-1/2"	19	113-006LQ	3	Pipe 1/2" NPT x 3-1/2"
7	169-722	1	Elbow 1-1/4" x 1" NPT	20	113-006QX	1	Pipe 1-1/4" NPT x 7-3/32"
8	169-724	1	Pipe Plug 1-1/4" NPT	21	S27-282	1	1/2" Ball Valve with Nut
9	113-006LL	1	Pipe 1" NPT x 9"	21.1	110-215	1	Jam Nut only
10	S30-059	1	Stay-Open Ball Valve Assy. 1" NPT	22	128-135	1	Handle
10.1	142-002DC	1	Lockwasher	23	142-002DA	1	Lockwasher
10.2	128-129	1	Handle	24	169-764	1	90° Pipe Elbow 1-1/4" NPT
10.3	S27-278	1	1" Ball Valve with Nut	25	113-006LE	1	Pipe 1-1/4" NPT x 3"
10.31	110-214	1	Nut only	26	S90-285	1	Stainless Steel Bowl Assy.
10.4	140-720	1	Stop Bracket	26.1	111-039	1	Inlet Drain Fitting
10.5	124-048	1	Washer, Friction	26.2	124-028	1	Center Seal Gasket
11	151-001	2	Curtain Hook	26.3	187-053	1	Stainless Steel Eyewash Bowl
12	113-006LK	1	Pipe 1" NPT x 12"	26.4	173-009	1	Cup Strainer
13	169-847	1	90° Elbow 1" NPT	26.5	S21-071	1	Supply Pipe
14	S24-189	1	Stainless Steel Showerhead Assy.	26.6	113-1159	1	Spacer, Drain
14.1	S24-193	1	Shroud Assembly	26.7	S05-091	1	Eyewash yoke
14.11	187-053	1	Showerhead Shell	26.8	107-371	2	Tethered Dust Cover
14.12	154-147	1	Ring	27	114-052	1	Safety Sign
14.2	S24-188	1	Plastic Showerhead Assembly	28	204-421	1	Emergency Tag

Prepack S45-122 includes items 21, 21.1, 22, 23

Prepack S45-123 includes items 21.1, 22, 23