



T&S BRASS AND BRONZE WORKS, INC.
 2 SADDLEBACK COVE / P.O. BOX 1088 / TRAVELERS REST, SC 29690
 PHONE 800-476-4103 FAX 864- 834-3518



Model No.

B-0109-05

Item No.:

Job Name:

Architect/Engineer Approval:

Notes:

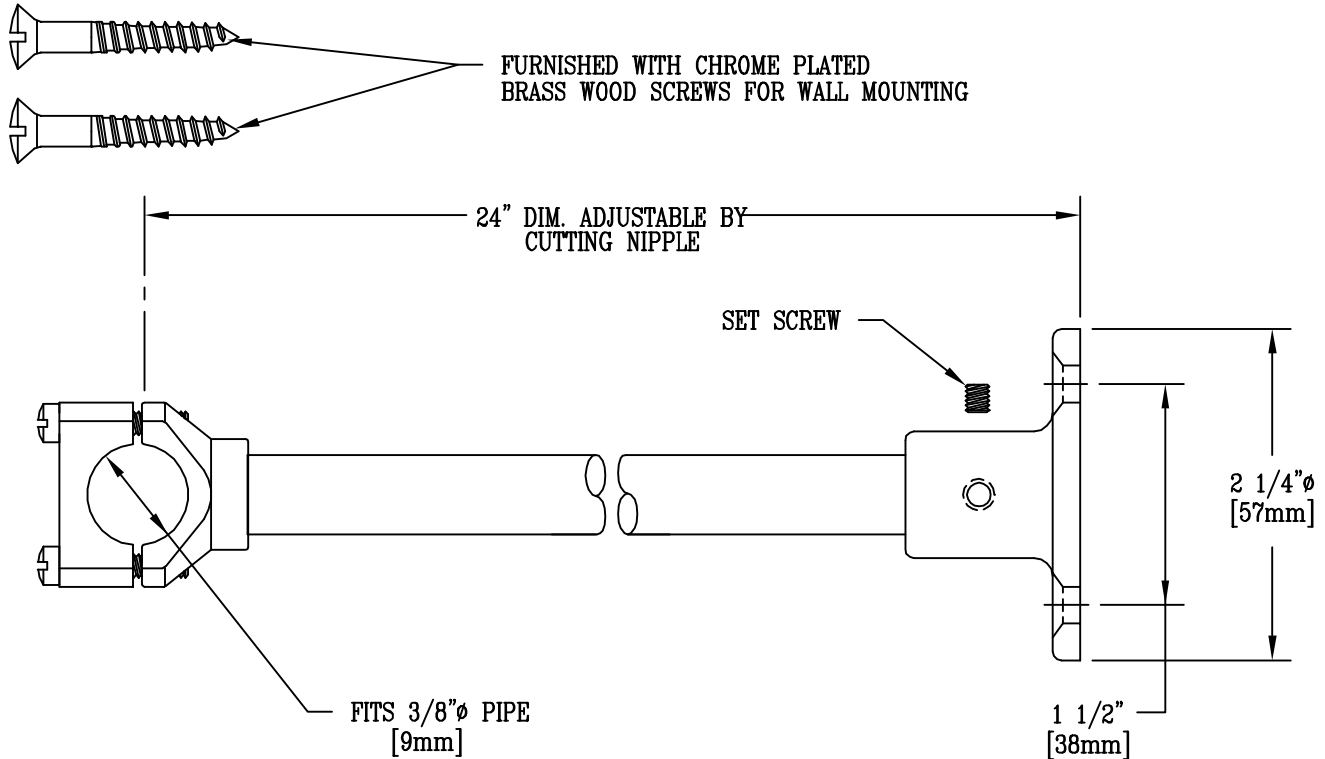

RECOMMENDED FOR USE WITH ALL UPRIGHT PRE-RINSE UNITS.

Product Description:
 24" WALL BRACKET ASSEMBLY
 WITH MOUNTING HARDWARE

Drawn:

MCW

Approved

CA

Checked

MW

Scale:

9" = 1'

Date:

10-17-95