



T&S BRASS AND BRONZE WORKS, INC.

2 Saddleback Cove / P.O. Box 1088
Travelers Rest, SC 29690



REG. #A2601
ISO #9001

Model No.

BL-4100-04

Item No.

Travelers Rest, SC: 800-476-4103 Simi Valley, CA: 800-423-0150 Fax: 864-834-3518 www.tsbrass.com

This Space for Architect/Engineer Approval

Job Name _____ Date _____

Model Specified _____ Quantity _____

Customer/Wholesaler _____

Contractor _____

Architect/Engineer _____

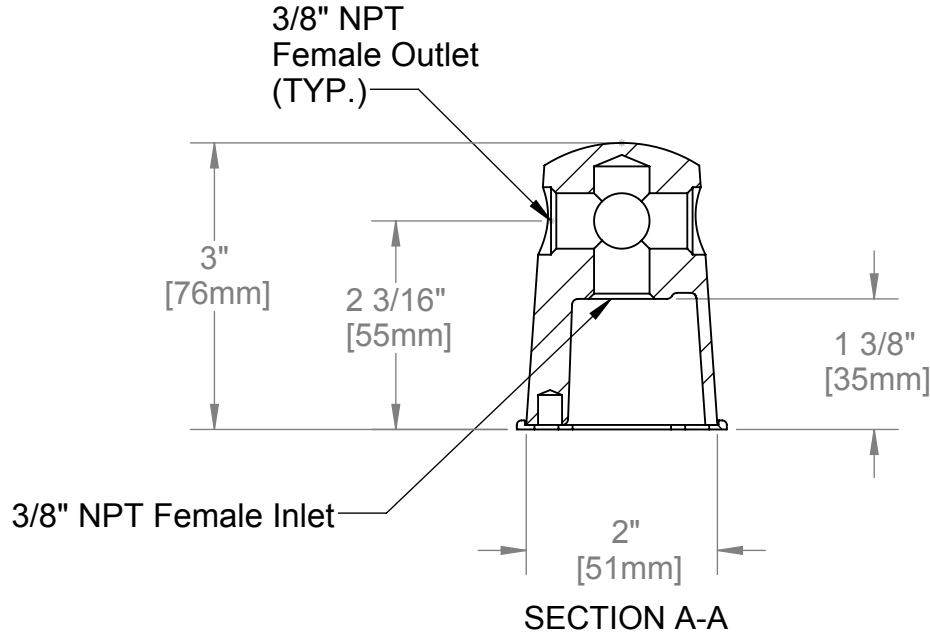
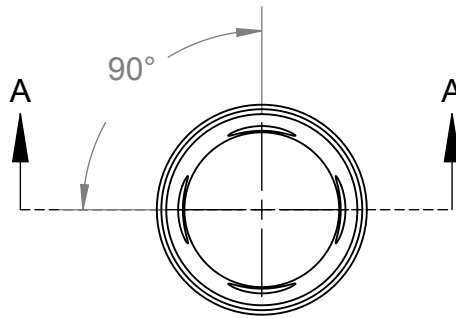

Product Specifications:
Gas Turret w/ (4) Outlets 90° Apart

Drawn
ARH

Checked
JRM

Approved
JHB

Scale:

1:2

Date:

01/10/07