

3202G

Pedestal Mounted Drinking Fountain



FEATURES & BENEFITS

Bubbler Head

Polished chrome-plated brass bubbler head features an integral basin shank for added strength, and is equipped with a shielded, anti-squirt orifice that provides a steady sanitary source of water.

Construction

Heavy-duty 12 gauge galvanized steel finish that incorporates a recessed push button and welded bubbler guard to provide extra durability, a large access panel for ease of service, and a vandal-resistant bottom plate for added peace of mind.

Drain Free

Unique design allows this pedestal fountain to be placed in the harshest of outdoor environments without the worry of a clogged drain. When water is activated, the excess flow runs from its trough basin off the back and onto the ground - perfect for beaches, play grounds, and other areas high in debris.

Push Button

With its patented (Pat.# 6,981,692) push-button valve assembly which allows for front access stream adjustment as well as cartridge and strainer access, this fountain offers the ultimate in ease of maintenance.



OPTIONS

- Bubbler Head: Model 5725 EnviroGard™ bubbler is a polished chrome-plated solid brass bubbler head with stainless steel water activated pop up canopy. (Pat.# 7,025,282)
- Hose Bib: Model 6275, compression hose bib faucet assembly with rough chrome-plated finish.
- Bib Faucet: Model 6250LF, self-closing, plain end, lead-free, brass bib faucet with polished chrome-plated finish.
- Filter: Model 6426, 12" x 2", in-line lead removal element that reduces lead from incoming water supply.

SPECIFICATIONS

Model 3202G barrier-free pedestal drinking fountain shall include a 12 gauge galvanized steel pedestal, push-button operated valve with front-accessible cartridge and flow adjustment, polished chrome-plated brass vandal-resistant bubbler head backed against a pedestal guard, trough design in the pedestal instead of a waste to eliminate clogging and a 1/4" spacer to raise the pedestal off the ground which reduces the potential for corrosion, integral mounting feet, and an over-size vandal-resistant access plate.

APPLICATIONS

Perfect for either public or private settings, the 3202G trough style fountain is a great fit in areas more prone to drain clogging. Completely eliminating the need for a traditional fountain drain, trough fountains are a nice complement to outdoor environments where a gravel fill can be implemented. Heavy-duty steel and galvanized finish make for a solid freestanding design that will hold up and blend in with the environment. More specifically, this fountain is applicable in forest/campground environments as well as parks, schools, and other outdoor areas where drinking facilities are needed.

Model meets all current Federal Regulations for the disabled including those in the Americans with Disabilities Act. Haws manufactures drinking fountains, electric water coolers and electric drinking fountains to be lead-free by all known definitions including ANSI/NSF Standard 61, Section 9, California Proposition 65, and the Federal Safe Drinking Water Act.



THIS DOCUMENT IS TRUE AND CORRECT AT TIME OF PUBLICATION. CONTINUED PRODUCT IMPROVEMENTS MAKE SPECIFICATIONS AND MEASUREMENTS SUBJECT TO CHANGE WITHOUT NOTICE.

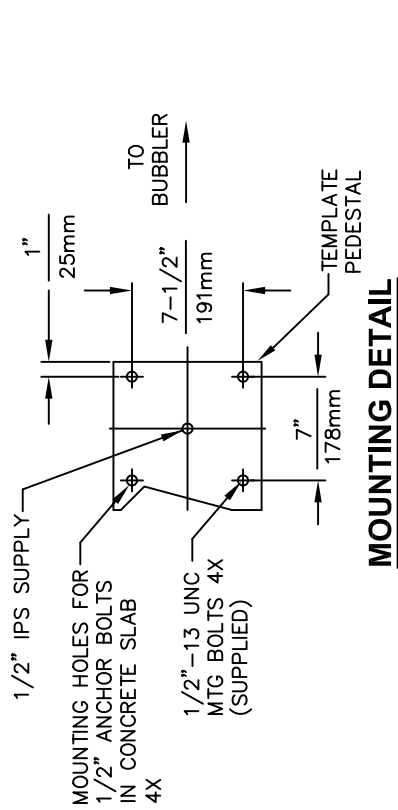

MOUNTING DETAIL

IMPORTANT: ATTENTION INSTALLER

USE CARE TO AVOID KINKS WHEN ROUTING SUPPLY LINE TO VALVE AND FROM VALVE TO BUBBLER

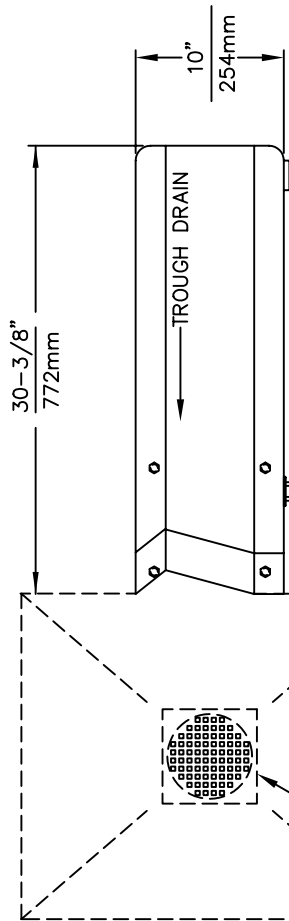

SLOPE CONCRETE TO FLOOR TYPE SEWER DRAIN (OR POROUS FILL DRAIN PIT IF DESIRED. RECOMMEND 30 CUBIC FEET MINIMUM POROUS FILL, MAY VARY DEPENDING UPON LOCAL GROUND CONDITIONS).

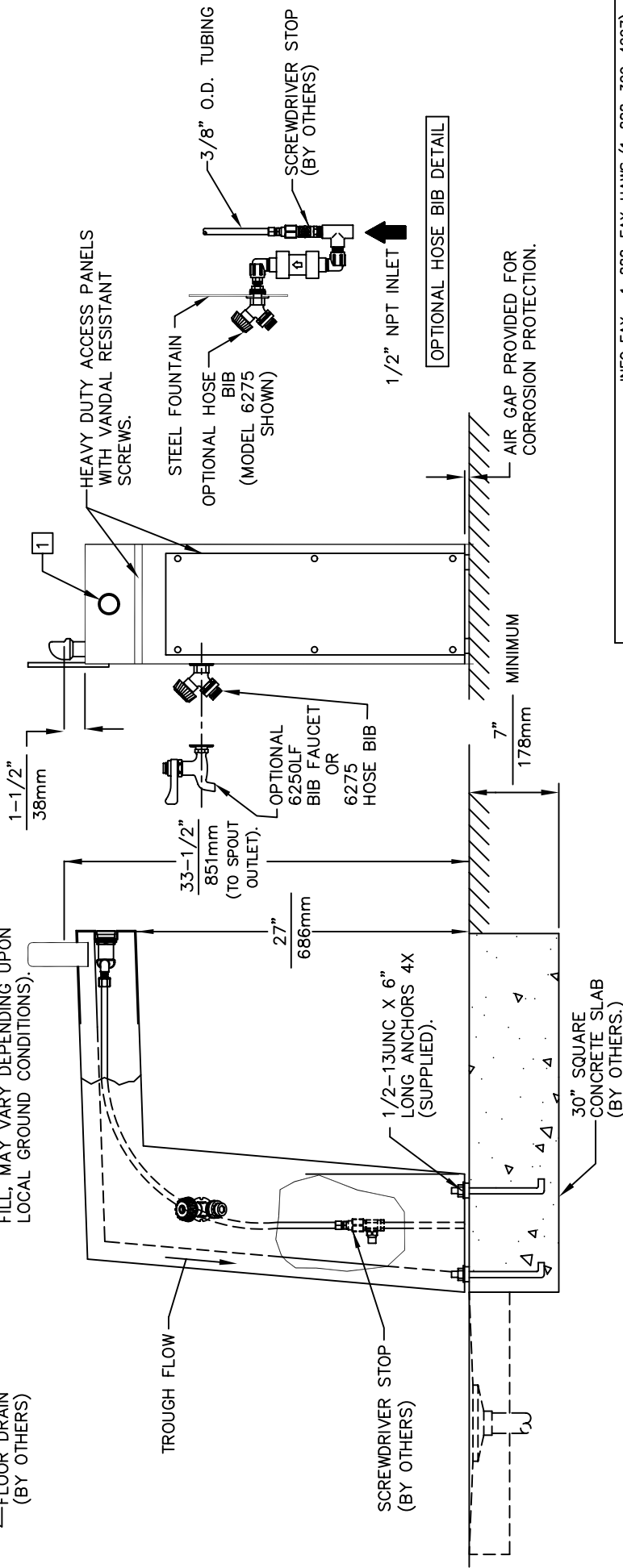

NOTES:

- [1] REFER TO 5874/VRK5874 OPERATION AND MAINTENANCE MANUAL FOR PUSH BUTTON AND VALVE INSTALLATION/MAINTENANCE INSTRUCTIONS.

INFO FAX : 1-888-FAX-HAWS (1-888-329-4297)
 1455 Kleppe Ln, Sparks NV, 89431
 Phone: 775-359-4712 Fax: 775-359-7424
 Haws Ag, Bachweg 3, CH-3401 Burgdorf Switzerland
 Haws Mfg Pte Ltd 74 Sungai Kadut Loop Singapore 729531
 e-mail: Haws@hawsco.com website: www.hawsco.com

FOR NO.:	ECN: 4166	REV:	3202/3202G
DATE:	11/01	BY:	
APPROVED:		DATE:	
SCALE:	1:1	INFO FAX DOC #:	23202/32024
DRAWING TYPE:		INSTALLATION/FABRICATION	
NO.:	000007	REV:	00
DATE:	09/12/00	BY:	20
SCALE:	A	SHEET:	1 OF 1



INSTALLATION, OPERATION & MAINTENANCE INSTRUCTIONS

1455 Kleppe Lane ♦ Sparks, NV 89431-6467 ♦ (775) 359-4712 ♦ Fax (775) 359-7424
HAWS AG ♦ Bachweg 3 ♦ CH-3401 Burgdorf ♦ Switzerland
Haws Mfg. Pte Lt. ♦ 2A Sungei Kadet Drive ♦ Singapore 729554
Avlis-Avenida Senador, Testonio Vilela ♦ 505 Jardim Aeroporto ♦ Itu, S.P. 13304-550 ♦ Brasil
E-mail: haws@hawsco.com ♦ website: www.hawsco.com

No. 2077328(20)

Model 3202/3202G Drinking Fountain

NOTE TO INSTALLER: Please leave this information with the Maintenance Department.

LIMITED WARRANTY

HAWS® warrants that all of its products are guaranteed against defective material or poor workmanship for a period of **one year from date of shipment**. HAWS liability under this warranty shall be discharged by furnishing without charge F.O.B. HAWS Factory any goods, or part thereof, which shall appear to the Company upon inspection to be of defective material or not of first class workmanship, provided that claim is made in writing to company within a reasonable period after receipt of the product. Where claims for defects are made, the defective part or parts shall be delivered to the Company, prepaid, for inspection. HAWS will not be liable for the cost of repairs, alterations or replacements, or for any expense connected therewith made by the owner or his agents, except upon written authority from HAWS, Sparks, Nevada. HAWS will not be liable for any damages caused by defective materials or poor workmanship, except for replacements, as provided above. Buyer agrees that Haws has made no other warranties either expressed or implied in addition to those above stated, except that of title with respect to any of the products or equipment sold hereunder and that HAWS shall not be liable for general, special, or consequential damages claimed to arise under the contract of sale. The drinking fountain manufactured by HAWS is warranted to function if installation and maintenance instructions provided are adhered to. The units also must be used for the purpose for which they were intended.

NO OTHER WARRANTIES EXPRESSED OR IMPLIED ARE AUTHORIZED, PROVIDED OR GIVEN BY HAWS.

SHOULD YOU EXPERIENCE DIFFICULTY WITH THE INSTALLATION OF THIS MODEL, PLEASE CALL:

1-800-766-5612

FOR PARTS CALL:

1-800-758-9378

**(U.S.A. AND CANADA ONLY) MONDAY-THURSDAY: 6:00 A.M. – 4:00 P.M. PST
FRIDAY: 6:00 A.M – 1:00 P.M. PST**

RECOMMENDED TOOLS: Hack saw, pipe joint sealant, screwdriver, level, 12" adjustable wrench, 10" pipe wrench, 5/64" hex key wrench, 9/16", 1/2", 7/16" socket wrench or open end wrench.

LOCATION OF UNIT: The Model 3202/3202G Drinking Fountain is a wheelchair accessible drinking water facility. The height dimensions shown, meet current ADA requirements. When installing this unit, local, state or federal codes should be adhered to. If height other than shown is required, then dimensions must be adjusted accordingly.

SUPPLY LINE: The minimum recommended line size is 1/2" IPS with 30-90 psi (2-6 ATM) pressure. Where sediment or mineral content is a problem, an inlet filter is recommended.

PLUMBING CONNECTIONS: Inlet is 1/4" IPS male fitting.

MAINTENANCE: Periodically clean the strainer. Refer to 5874 Valve Manual for more information.

TROUBLESHOOTING

PROBLEM	REPAIR CHECKLIST
1. Insufficient bubbler flow.	1a. Check that inlet screwdriver stop valve is in wide-open position. b. Verify minimum 30 psi flowing supply pressure. c. Clean strainer. See 5874 Valve Manual. d. Adjust valve to increase flow. Use front adjust screw or see 5874 Valve Manual.

ITEM	DESCRIPTION
1	PUSH BTN ASS'Y PBA7
2	VALVE 5874
3	BUBBLER HEAD 5703M
4	SPANNER WRENCH P/N 0006983506
5	HOSE BIB 6275 (OPTIONAL)
6	1/2" STOP ASSY. 6449 (OPTIONAL)
7	BIB FAUCET 6250LF (OPTIONAL)

PARTS BREAKDOWN

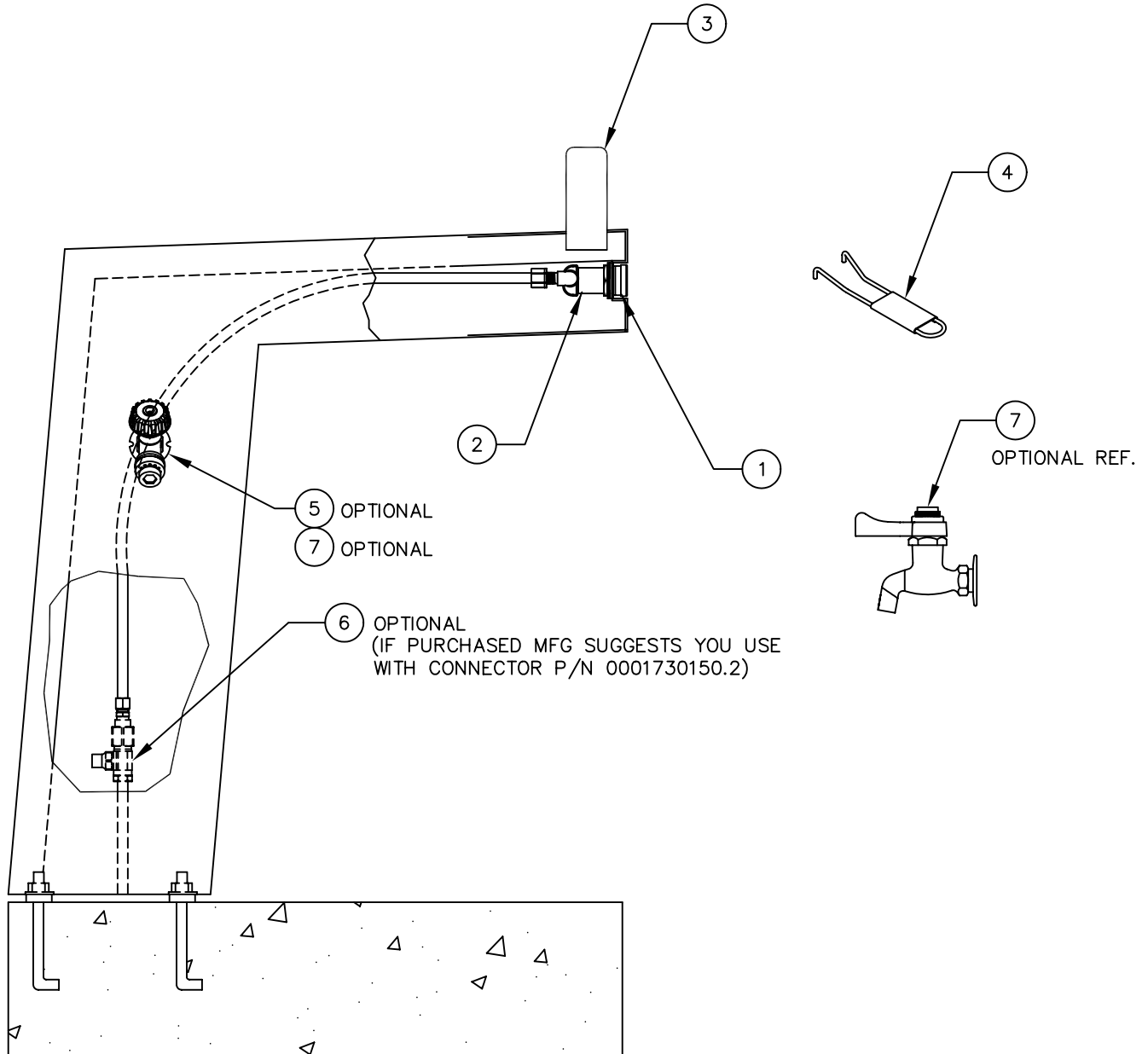

WHEN ORDERING PARTS PLEASE SPECIFY YOUR MODEL NUMBER			1455 KLEPPE LANE SPARKS, NEVADA		BACHWEG 3 CH3401 BURGDORF SWITZERLAND	
	DRAWN BY: D. OLLOM	DATE: 11/25/95	CHECK BY:	APP'D BY:	SCALE: 1/4	
	TITLE: 3202/320G				PART NUMBER: 0002077328	
	DRAWING TYPE: PARTS BREAKDOWN				DRAWING NUMBER: 12812C00	REV: 20

THIS DOCUMENT IS TRUE AND CORRECT AT TIME OF PUBLICATION. CONTINUED PRODUCT IMPROVEMENTS MAKE SPECIFICATIONS AND MEASUREMENTS SUBJECT TO CHANGE WITHOUT NOTICE.

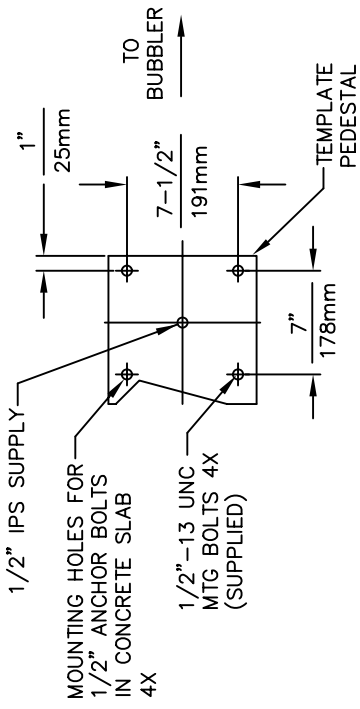
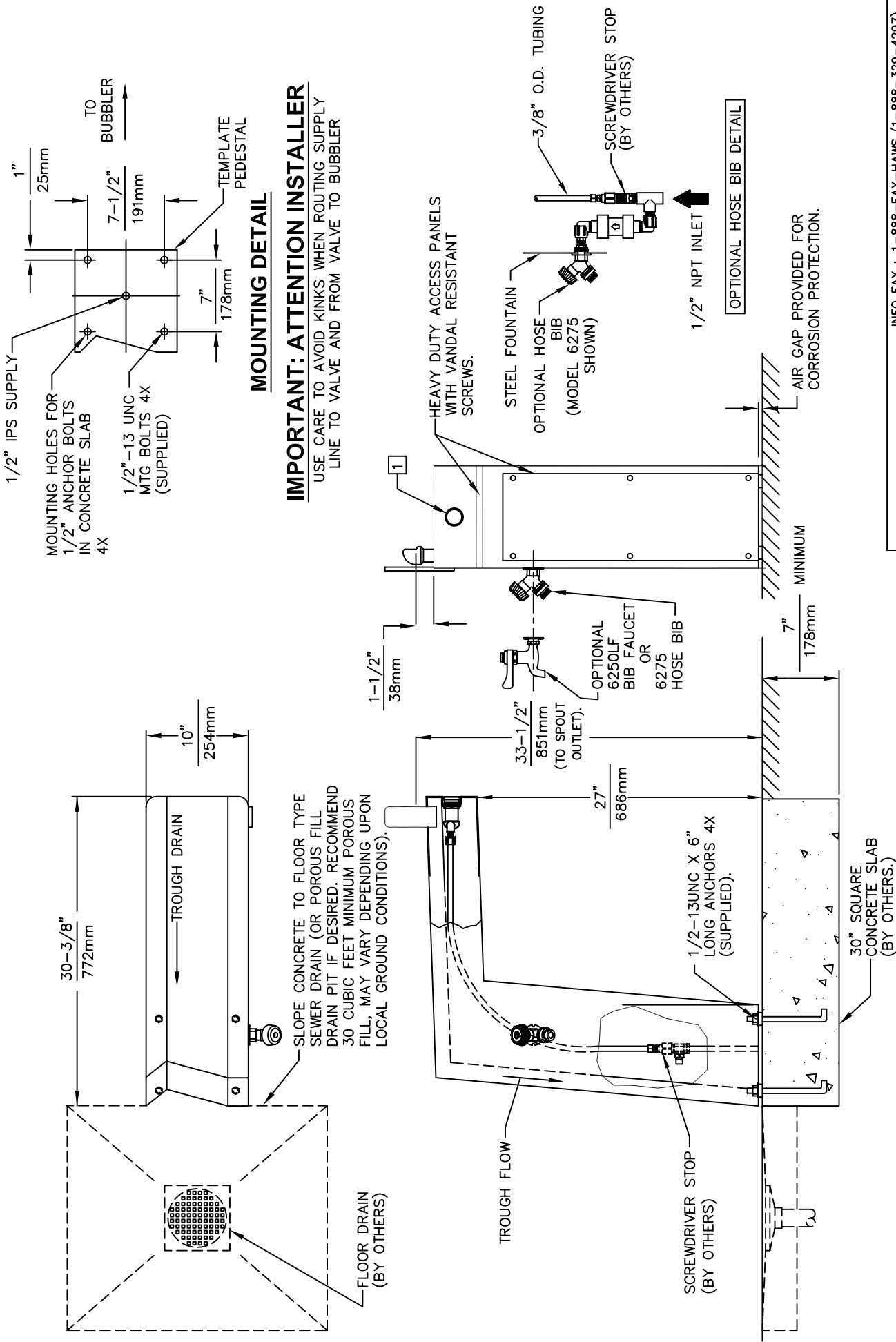

MOUNTING DETAIL

IMPORTANT: ATTENTION INSTALLER

USE CARE TO AVOID KINKS WHEN ROUTING SUPPLY LINE TO VALVE AND FROM VALVE TO BUBBLER

NOTES:

- 1 REFER TO 5874/VRK5874 OPERATION AND MAINTENANCE MANUAL FOR PUSH BUTTON AND VALVE INSTALLATION/MAINTENANCE INSTRUCTIONS.

Haws Corporation
 INFO FAX : 1-888-FAX-HAWS (1-888-329-4297)
 1455 Kleppe Ln, Sparks NV, 89431
 Phone: 775-359-4712 Fax: 775-359-7424
 Haws Ag, Bachweg 3, CH-3401 Burgdorf Switzerland
 Haws (S) Pte Ltd, 74, Sungai Kadut Loop, Singapore 729531
 e-mail: Haws@hawsco.com website: www.hawsco.com

FOR NO.:	ECN: 4166	REV:	3202/3202G
DATE:	11/01	BY:	
APPROVED:		DATE:	
SCALE:	1:1	INFO FAX DOC #:	23202/32024
DRAWING TYPE:		INSTALLATION/FABRICATION	
REV:	09312A00	REV:	09312A00
SIZE:	A	SH:	1 OF 1