

Water Connects Us®

## SLOAN DECK MOUNTED SOAP DISPENSER (ESD-SERIES) INSTALLATION INSTRUCTIONS



ESD-500



ESD-600



ESD-700



ESD-800



ESD-1500



ESD-2000



ESD-2100

### Touchfree Counter Mounted System Installation Guide

If there is a dispenser currently installed

- Remove the existing unit, both the above and below counter assemblies
- Clean the counter area where the previous dispenser was located
- Verify the size of the existing counter hole is 15/16" to 1-1/4" in diameter

If there is no hole in the counter

- Prior to drilling, examine below the counter to ensure adequate clearance for the new unit
- Drill a 1" diameter hole in the counter top
- The hole can be drilled to either the right or left of the faucet, ensuring adequate clearance for the below counter assembly
- Clean the counter area where the new hole is located

### Prior To Installation

New Soap Dispenser Installation:

- Ensure that dispenser does not interfere with anything above or below the lavatory/counter top area
- Drill a 1" diameter hole in counter top
- Clean area around hole

### To Order Replacement Soap Cartridges

800.321.9647

GOJO Industries

Refills are also available through your local plumbing or janitorial supply distributor.

When the soap bottle is empty, a new bottle must be used. The bottle furnished with the unit is not designed to be refilled. Altering the bottle and refilling it with soap will void the warranty of the product.

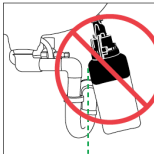

Improper installation of the Counter Mounted Dispenser could result in breakage.

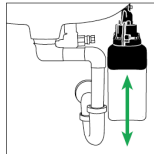

Proper installation allows the unit to vertically hang beneath the sink.

Dispenser must hang freely underneath the sink.

### LIMITED WARRANTY

Unless otherwise noted, Sloan Valve Company warrants its Products to be made of first class materials, free from defects of material or workmanship under normal use and to perform the service for which they are intended in a thoroughly reliable and efficient manner when properly installed and serviced, for a period of three years (1 year for SF Faucets, special finishes and PWT electronics and 30 days on PWT software) from date of purchase. During this period, Sloan Valve Company will, at its option, repair or replace any part or parts which prove to be thus defective if returned to Sloan Valve Company, at customer's cost, and this shall be the sole remedy available under this warranty. No claims will be allowed for labor, transportation or other incidental costs. This warranty extends only to persons or organizations who purchase Sloan Valve Company's products directly from Sloan Valve Company for purpose of resale. This warranty does not cover the life of the batteries.

**THERE ARE NO WARRANTIES WHICH EXTEND BEYOND THE DESCRIPTION ON THE FACE HEREOF. IN NO EVENT IS SLOAN VALVE COMPANY RESPONSIBLE FOR ANY CONSEQUENTIAL DAMAGES OF ANY MEASURE WHATSOEVER.**

**SLOAN • 10500 SEYMOUR AVENUE • FRANKLIN PARK, IL 60131**

Phone: 1-800-9-VALVE-9 or 1-847-671-4300 • Fax: 1-800-447-8329 or 1-847-671-4380 • [www.sloan.com](http://www.sloan.com)

# Soap Dispenser Installation

**NOTE: ESD-2100 Shown, instructions applicable for all Sloan soap dispensers**

## Installing the Touchfree Counter Mounted System

Prior to beginning installation, study the exploded view of the Touchfree Counter-Mounted System and locate all the pieces. Also, look beneath the countertop to a suitable place for mounting of the Battery Box (9) so that it will not interfere with system components or plumbing.

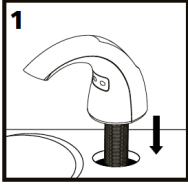

Feed the Data Cable 5a and the shank of the Dispenser Assembly 1 through the hole in the countertop. Point the spout of the Dispenser into the sink bowl.

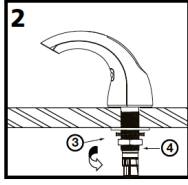

From underneath the counter, feed the Lock Washer 3 and then the Mounting Nut 3a over the Data Cable 5a and onto the threaded shank of the Dispenser Assembly 1. Tighten the nut securely.

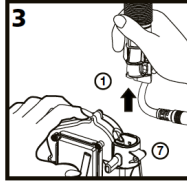

Align the indent inside the top of the Motor Assembly/Bottle Support 7 with the indent on the shank of the Dispenser Assembly 1 and firmly push the Motor Assembly/Bottle Support up, onto the shank.

**NOTE:** Hold the Data Cable firmly out of the way as you push up on the Motor Assembly/Bottle Support. Continue pushing upward until the vertical slots in the Dispenser shank and the Motor Assembly/Bottle Support line up.

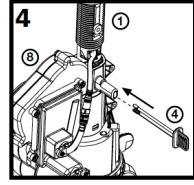

Secure the Motor Assembly/Bottle Support 7 to the Dispenser Assembly 1 shank by pushing the Retaining Clip 4 into place through the vertical slots, until it goes all the way through the Motor Assembly.

**NOTE:** Motor Assembly Bottle Support will rotate 360° to avoid any obstruction.

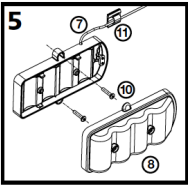

Remove the cover from the Battery Box 8 by loosening the two captive screws on the Battery Box cover. Position the Box on a convenient (vertical or horizontal) surface under the counter top that will allow access for battery changing. Attach the Box to the surface using the two screws 10 and anchors (if attaching to a plaster or masonry surface). Use the Wall Clip 11 to secure the Power Cable to a wall or other under-counter surface if desired.

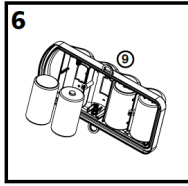

Place four alkaline "D" Cell batteries into the Battery Box 9 cover. The batteries must be positioned according to the diagrams shown on the inside of the cover.

**NOTE:** If the batteries are not properly installed or the cover is not properly positioned on the Box, the System will not work. Position the cover (with batteries installed) on the Battery Box and tighten the two captive screws.

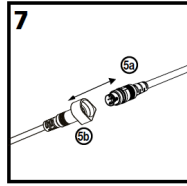

**IMPORTANT:** Connect the two halves of the Data Cable 5a and 5b by visually lining up the white stripes on each half and gently pushing the cable connectors together until the stripes touch.

**Improperly assembled connectors can cause unit to not function as intended.**

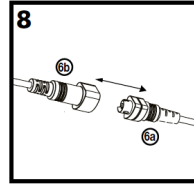

After the batteries are installed in the battery box, connect the two halves of the power cable 6a and 6b. Allow 20 seconds before the system is ready to dispense soap.

# Soap Refill Bottle Installation and Removal

## Refill Installation

(refill 9 sold separately)

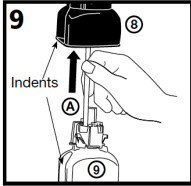

Feed the dispense tube A on the Refill Bottle 9 up through the Motor Assembly/Bottle Support 7 and Dispenser Assembly 1, aligning the two indents in the Bottle and the Support. Slide the Bottle upward until it snaps into place.

**NOTE:** The refill is not properly installed until you hear the "snap" (as the Green release latch on the Motor Assembly/Bottle Support 7 engages).

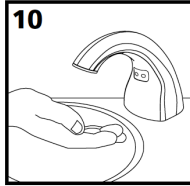

Test the System by passing your hand under the spout of the Dispenser Assembly 1 (in front of the sensor window) at least three or four times, until foam soap appears. If the System does not dispense soap after passing your hand in front of the sensor several times, repeat several more times. If no sound heard from motor assembly after placing hands in front of sensor, check to see that the Data Cable 6 halves are firmly connected, that the batteries are "good", and that the Battery Box 8 cover is properly positioned and fastened to the Box. Check for bent contact pins inside connector 6b. If unit is multi-activating, check for bent contact pins inside connector 6b.

## Refill Removal

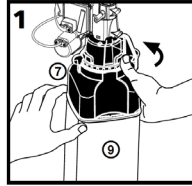

Grasp the empty Refill Bottle 9 with one hand and use the other hand to push the Green release latch on the Motor Assembly/Bottle Support 7 to the right (counterclockwise as seen from above).

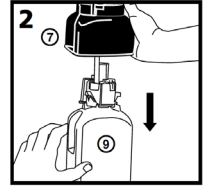

Grasp the empty Refill Bottle 9 with one hand and use the other hand to push the Green release latch on the Motor Assembly/Bottle Support 7 to the right (counterclockwise as seen from above).

### Cleaning the Counter Mounted System

Use only mild soap and water to clean the Touchfree Counter Mounted System spout. Cover the sensor window with your thumb while cleaning the spout so that you do not continue to dispense soap.

**DO NOT** use abrasives to clean the TouchFree Counter-Mounted System (as this may damage the finish or the sensor window).

## Soap Replacement

To order replacement soap cartridges:  
CONTACT **GOJO** Industries at 800.321.9647  
Available refills

ESD-321 8565-02-N6300GN: 1500 ml Green Certified Foam Refill (2 Pack)

ESD-322 8545-04-N6300GN: 2300 ml Green Certified Foam Refill (4 Pack)

**ATTENTION:** do not handle by tube. For proper operation, ensure that tubing is not loose or bent.

# Parts Breakdown

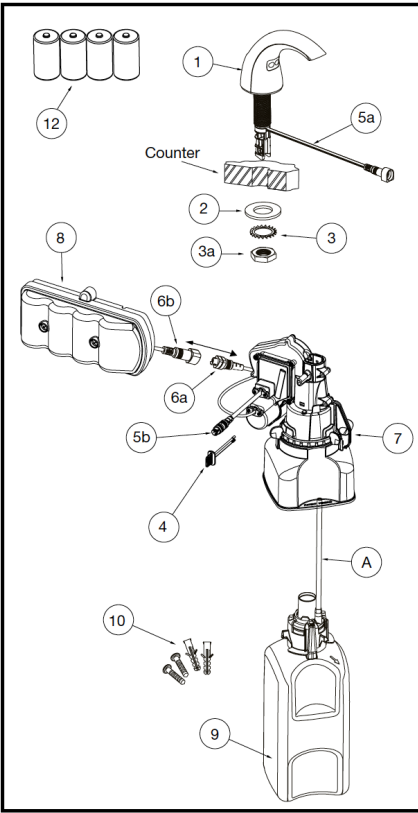

ITEM	DESCRIPTION	QTY.
1	DISPENSER ASSEMBLY	1
2	FLAT WASHER	1
3	LOCK WASHER	
3a	HEX NUT	1
4	RETAINING CLIP	1
5	DATA CABLE (2 HALVES WITH CONNECTOR - a and b)	1
6	POWER CABLE (2 HALVES WITH CONNECTOR - a and b)	1
7	MOTOR ASSEMBLY/BOTTLE SUPPORT	1
8	BATTERY BOX (USES 4 "D" CELL BATTERIES PROVIDED)	1
9	REFILL BOTTLE (SOLD SEPARATELY)	1
10	SCREWS & ANCHORS FOR BATTERY BOX MOUNTING	2 EA.
11	WALL CLIP FOR POWER CABLE	1
12	"D" CELL BATTERIES (PROVIDED)	4

**SLOAN • 10500 SEYMOUR AVENUE • FRANKLIN PARK, IL 60131**

Phone: 1-800-9-VALVE-9 or 1-847-671-4300 • Fax: 1-800-447-8329 or 1-847-671-4380 • [www.sloan.com](http://www.sloan.com)