

COMMANDER®

SC-7114



Healthcare Fittings

GENERAL SPECIFICATION

Polished chrome plated Commander single handle laboratory faucet with 1/4 turn ceramic cartridges covered by a 25-year warranty. Accommodates installations up to 1-5/16" thick. 5-1/4" deep gooseneck spout, rigid or swivel. Vandal-resistant flow control reduces flow to 2.2 gpm/8.4 lpm. Meets ASME A112.18.1/CSA B125.1 and NSF61.

SC-7114

Laboratory faucet with vandal-resistant 4" wrist blade handle.

OPTIONS

SUFFIX	DESCRIPTION
<input type="checkbox"/> BO	0.5 gpm flow control, vandal-resistant
<input type="checkbox"/> CA**	No lead for CA AB1953 compliance
<input type="checkbox"/> FC*	2.0 gpm laminar flow control, plain end spout
<input type="checkbox"/> GB	1.5 gpm flow control, vandal-resistant
<input type="checkbox"/> LF	2.2 gpm laminar flow control outlet
<input type="checkbox"/> SO	Rose spray outlet
<input type="checkbox"/> 4*	3-3/4" deep spread gooseneck spout, rigid or swivel
<input type="checkbox"/> 8*	8" deep spread gooseneck spout, rigid or swivel
<input type="checkbox"/> 9*	9" deep tubular swing spout, rigid or swivel
<input type="checkbox"/> 12*	12" deep tubular swing spout, rigid or swivel
<input type="checkbox"/> VB6*	6" deep rigid vacuum breaker spout
<input type="checkbox"/> VB8*	8" deep rigid vacuum breaker spout

VACUUM BREAKER OPTIONS

SUFFIX	DESCRIPTION
<input type="checkbox"/> ST	Serrated tip
<input type="checkbox"/> SW	Swivel spout

*See page 177 for optional spout specifications

** The following options are not available with the "CA" option:
 SO, TWI, VB6, VB8, ST, SW, & TMV.

This space for Architect/Engineer approval.



ROUGH-INS

SC-7114

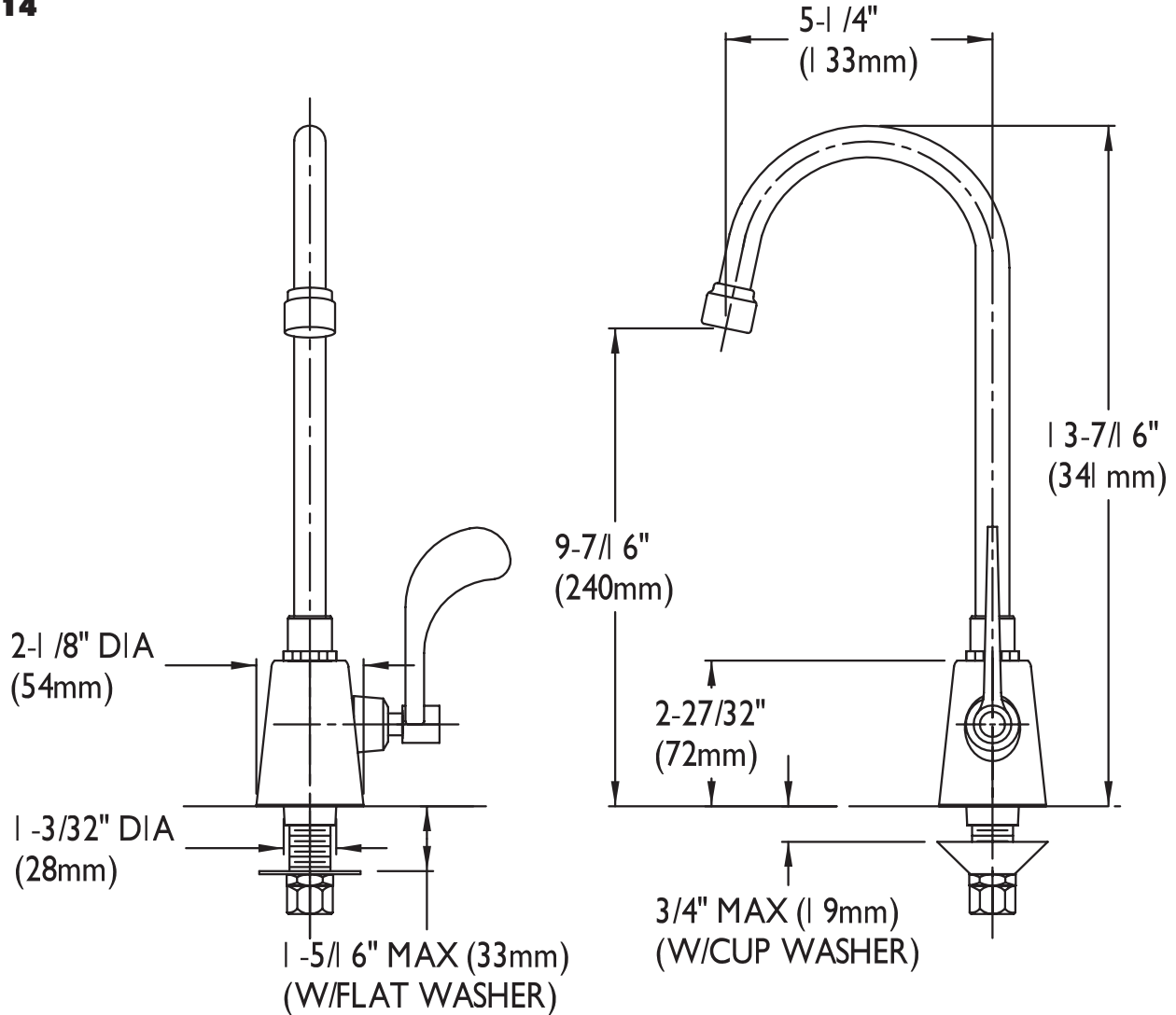

NOTE: Unless otherwise specified, inlet is 1/2" NPSM. Inlet is sized for either coupling or sweat connections. All dimensions are in inches unless otherwise specified and are subject to change without notice.



Spout -4, rigid or swivel
 3-3/4" deep gooseneck



Spout -4FC, rigid or swivel
 3-3/4" deep plain end gooseneck;
 laminar flow in base of spout



Spout -5, rigid or swivel
 5-1/4" deep gooseneck

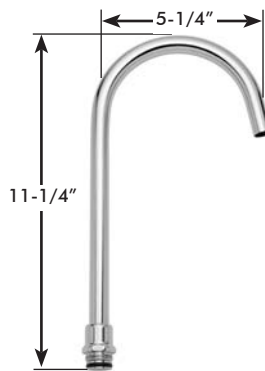

Spout -5FC, rigid or swivel
 5-1/4" deep plain end gooseneck;
 laminar flow in base of spout



Spout -8, rigid or swivel
 8" deep gooseneck



Spout -8FC, rigid or swivel
 8" deep plain end gooseneck;
 laminar flow in base of spout



Spout -9, rigid or swivel
 9" deep tubular swing spout

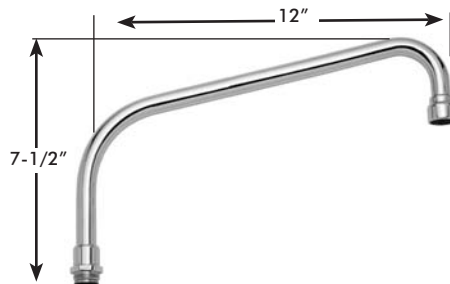

Spout -12, rigid or swivel
 12" deep tubular swing spout

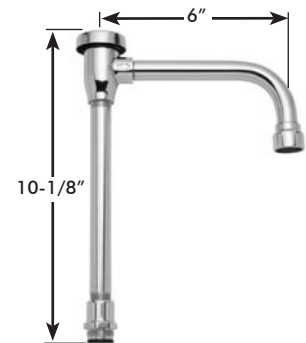

Spout -VB6, rigid
 6" deep rigid vacuum breaker spout

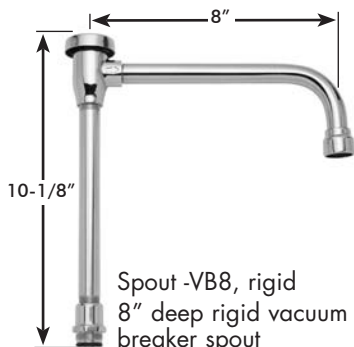

Spout -VB8, rigid
 8" deep rigid vacuum
 breaker spout

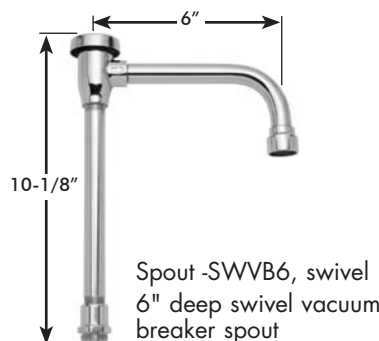

Spout -SWVB6, swivel
 6" deep swivel vacuum
 breaker spout

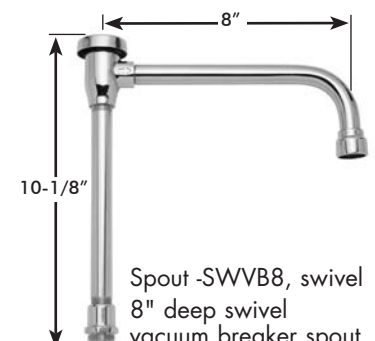

Spout -SWVB8, swivel
 8" deep swivel
 vacuum breaker spout