

COMMANDER®

SC-3088-LD



4" Centerset Gooseneck Combinations

GENERAL SPECIFICATION

Polished chrome plated Commander 4" centerset deck faucet with 1/4 turn ceramic cartridges covered by a 25-year warranty. Accommodates installations up to 7/8" thick. Centerset faucet with 3-3/4" deep spread gooseneck spout, rigid or swivel. Vandal-resistant water conserving flow control reduces flow to 2.2 gpm/8.4 lpm. Meets ASME A112.18.1/CSA B125.1 and NSF61.

Wing Handle Models

Vandal-resistant wing handle with color-coded indexes.

- SC-3088** Strainer drain
- SC-3088-LD** No drain assembly
- SC-3098** Solid brass 1-1/4" pop-up drain

OPTIONS

SUFFIX	DESCRIPTION
<input type="checkbox"/> BO	0.5 gpm flow control, vandal-resistant
<input type="checkbox"/> CA**	Low lead for CA AB1953 compliance
<input type="checkbox"/> FC*	2.0 gpm laminar flow control, plain end spout
<input type="checkbox"/> GB	1.5 gpm flow control, vandal-resistant
<input type="checkbox"/> LD	Less drain assembly (SC-3098 only)
<input type="checkbox"/> LF	2.2 gpm laminar flow control outlet
<input type="checkbox"/> MI	Metal index for handles
<input type="checkbox"/> SO	Rose spray outlet
<input type="checkbox"/> 5*	5-1/4" deep spread gooseneck spout, rigid or swivel
<input type="checkbox"/> 8*	8" deep spread gooseneck spout, rigid or swivel
<input type="checkbox"/> 9*	9" deep tubular swing spout, rigid or swivel
<input type="checkbox"/> 12*	12" deep tubular swing spout, rigid or swivel
<input type="checkbox"/> VB6*	6" deep rigid vacuum breaker spout
<input type="checkbox"/> VB8*	8" deep rigid vacuum breaker spout

VACUUM BREAKER OPTIONS

SUFFIX	DESCRIPTION
<input type="checkbox"/> ST	Serrated tip
<input type="checkbox"/> SW	Swivel spout

* See page 127 for optional spout specifications

** The following options are not available with the "CA" option: HS (Hose & Spray), SO, TWI, VB6, VB8, ST, SW, & TMV.

This space for Architect/Engineer approval.



ROUGH-INS

SC-3088-LD

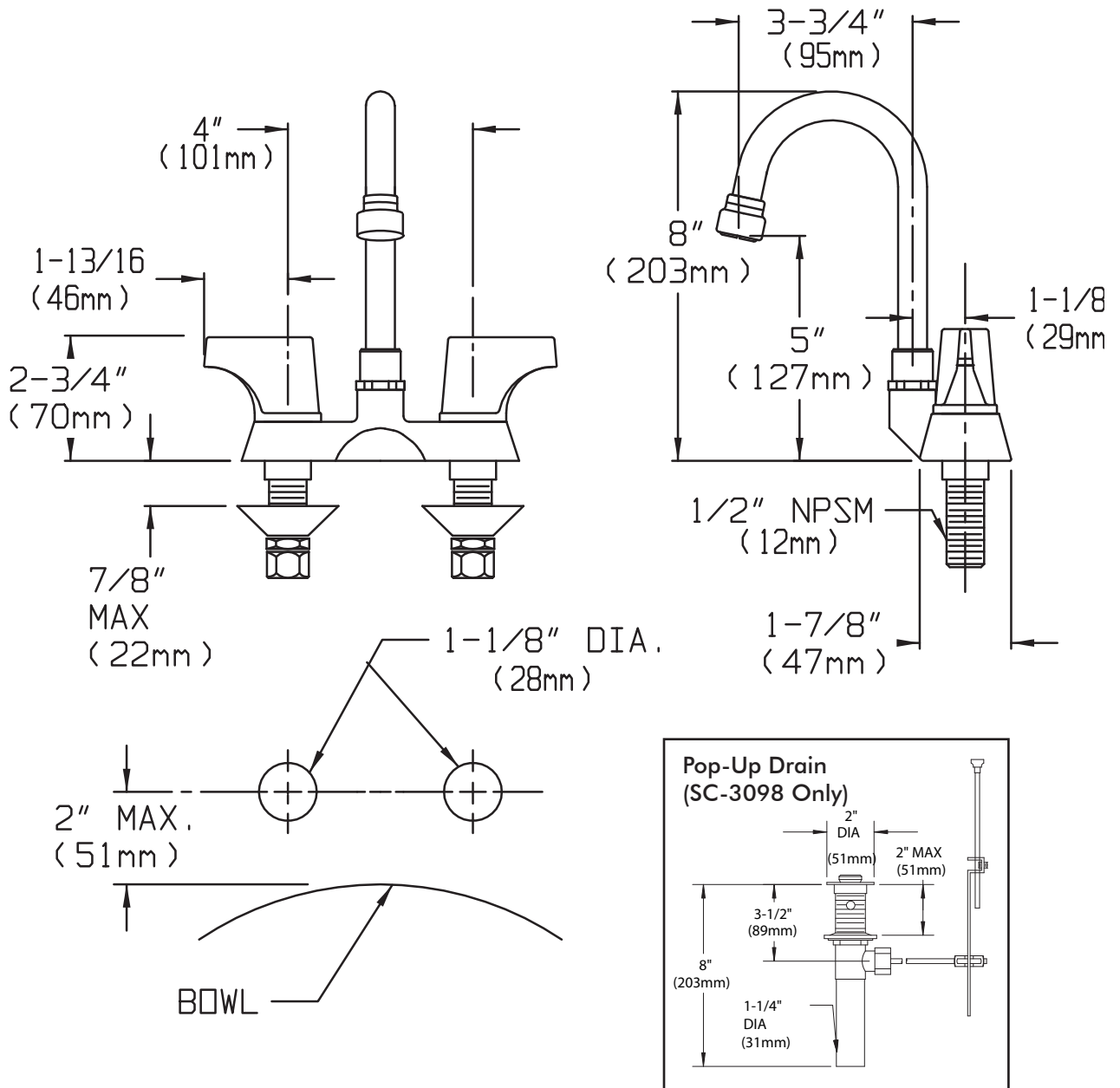

NOTE: All dimensions are in inches (millimeters) unless otherwise specified and are subject to change without notice. Lavatory inlets are sized for either coupling or sweat connections. Unless otherwise specified, all inlets are 1/2" NPSM.