

FEATURES

Model LK406AT08L2

- Two hole dual handle top mount faucet
- Quarter turn ceramic disc cartridge
- Solid brass construction
- Chrome finish
- Includes spout swing restriction pin

Model LK406AT08T4

- Same as LK406AT08L2 except with 4" wrist blades handles

Model LK406AT08T6

- Same as LK406AT08L2 except with 6" wrist blades handles

COMPLIES WITH:

- ASME/ANSI A112.18.1
- CSA B125-01
- NSF/ANSI 61
- ADA
- UPC/CUPC
- IAPMO Listed

Deck Mount 4" Center Commercial Faucet Models LK406AT08L2, LK406AT08T4, LK406AT08T6

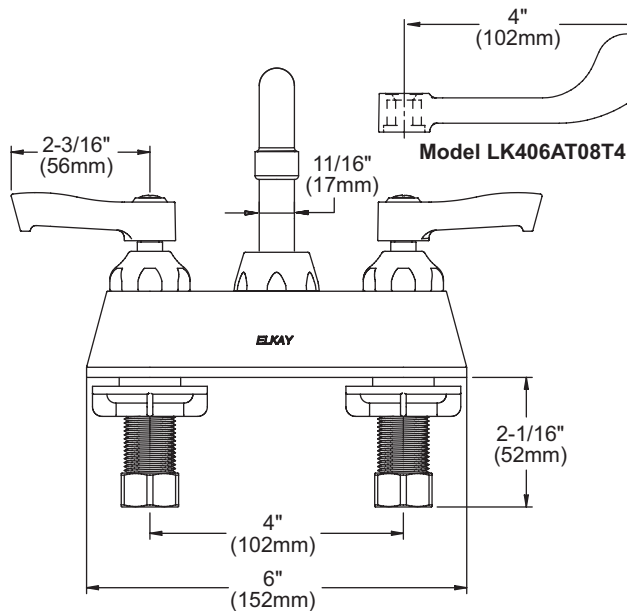
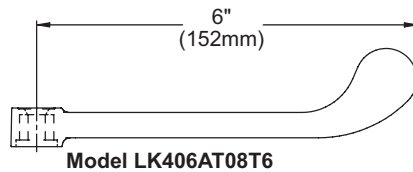

Model LK406AT08L2
FRONT VIEW

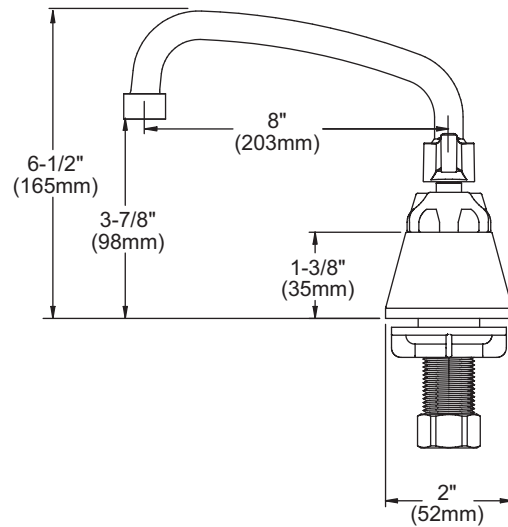

SIDE VIEW

Job Name:	Item #:
Notes:	
Architect/Engineer Approval:	Date:

SEE OTHER SIDE FOR REPLACEMENT PARTS



REPLACEMENT PARTS

Deck Mount 4" Center Commercial Faucet
Models LK406AT08L2, LK406AT08T4, LK406AT08T6

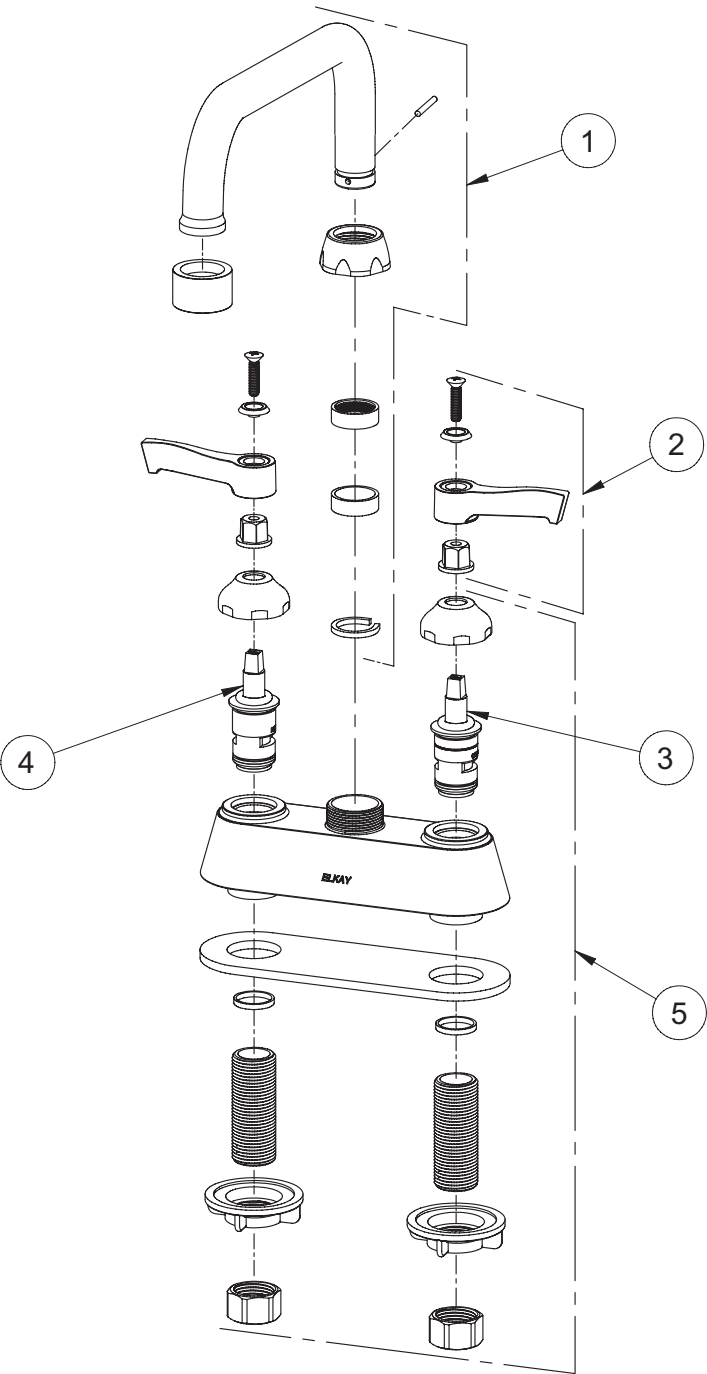

ITEM	IND. PART	DESCRIPTION
1	A55393	Spout
2	45918C	Handle
3	45923C	Right Cold Cartridge
4	45924C	Left Hot Cartridge
5	45917C	Body