



T&S BRASS AND BRONZE WORKS, INC.
 2 SADDLEBACK COVE / P.O. BOX 1088 / TRAVELERS REST, SC 29690
 PHONE 800-476-4103 FAX 864- 834-3518



Sales No.

006009-40

Item No.:

Job Name:

Architect/Engineer Approval:

Notes:

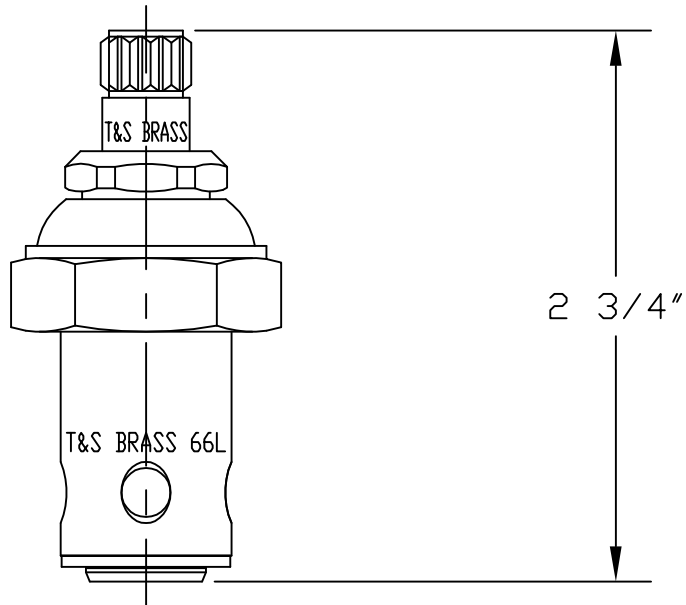

Product Description:

ETERNA CARTRIDGE ASM

Drawn:

WJS

Approved

Checked

Scale:

1 : 1

Date: